

TOSHIBA

Horizontal-Deflection Output Transistors

PRODUCT GUIDE

1 Outline

Toshiba has developed a range of fifth-generation horizontal-deflection-output transistors (HV-Trs). Radical redesign of the emitter electrode and the contact pattern has yielded significant improvements, resulting in higher current density and superior electrical characteristics compared to those of fourth-generation products. Toshiba's propriety glass-mesa structure results in a high breakdown voltage.

Thanks to Toshiba's wealth of experience and the wide variety of products which the company can offer, Toshiba horizontal-deflection-output transistors are used World-wide in color TVs and video display monitors.

2 Appearance, Package and Weight

The photographs below show the products and their markings. The packages shown are the straight-lead packages used for standard products.

● Appearance

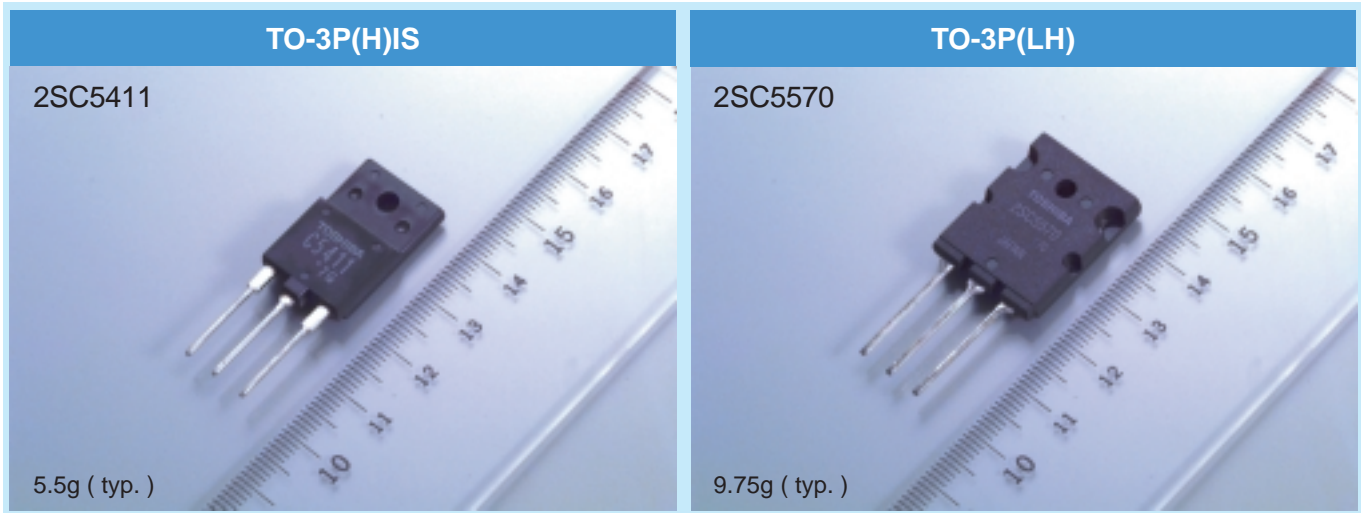

● Package dimensions

(Unit : mm)

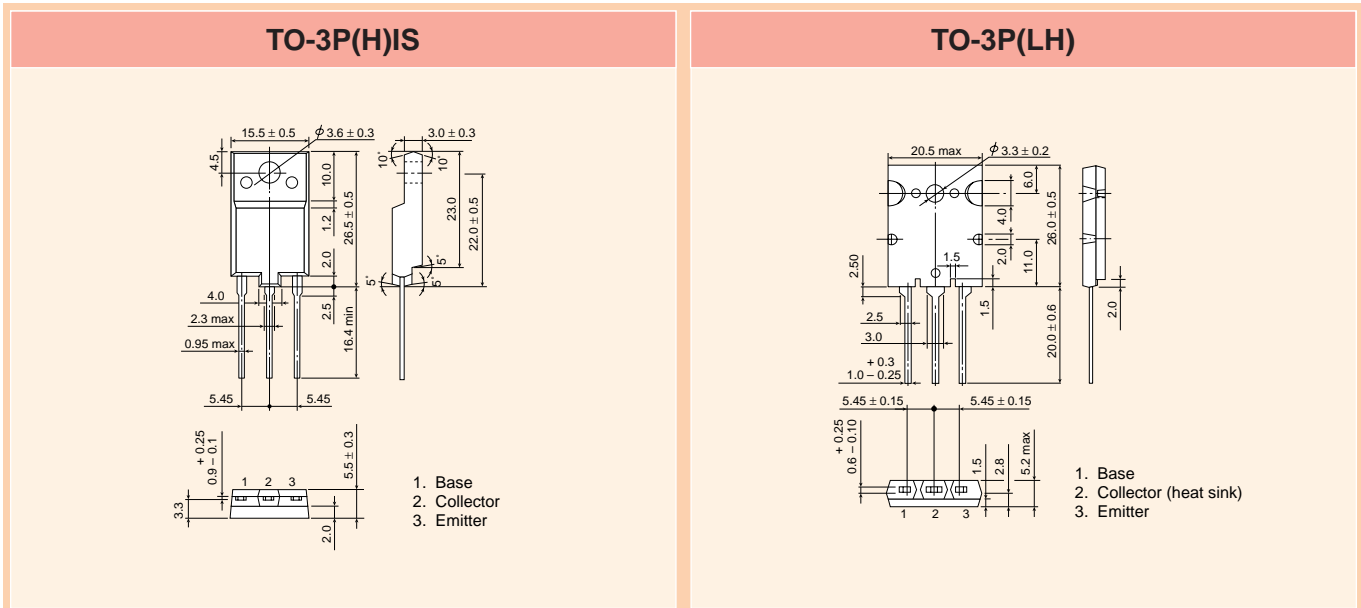

3 Device Trends

Market trends and the development of horizontal-deflection output transistors

Device Trends

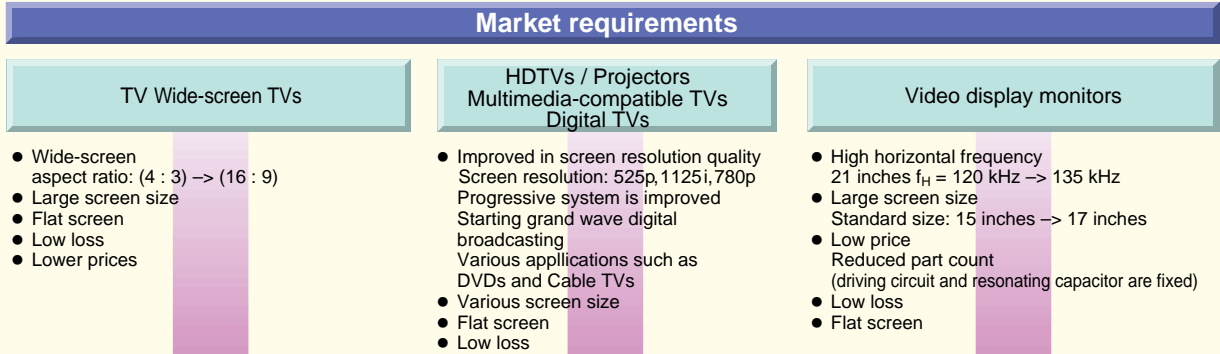

Development of Horizontal-Deflection Output Transistors

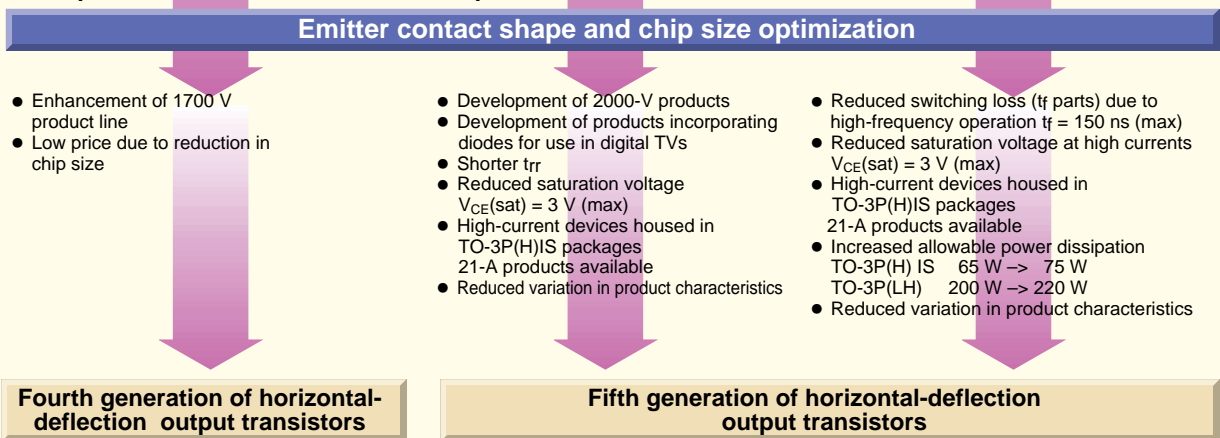

4 Features of Fourth and Fifth Generation

1 High breakdown capability

The product features a glass mesa structure, the use of which yields a wide forward- and reverse-biased safe operating area.

2 Low saturation voltage

$V_{CE(sat)} = 3 \text{ V (max)}$
Note: Used for 2SC-Series devices without damper diodes.

Toshiba's proprietary "glass mesa" structure

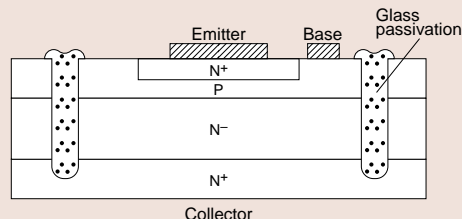

Contact shape

Conventional comb type

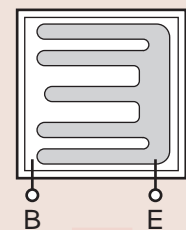

Fourth and fifth-generation mesh type

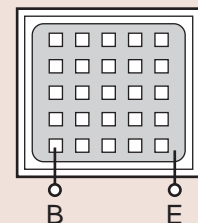

3 Wider range of optimum drive conditions

Fluctuation in optimum drive conditions due to variation in device quality has been minimized for ease of design.

3 Revised emitter contact shape and optimized chip size

Chip design has been optimized using Toshiba simulation technology. The emitter's contact area has been widened by changing the contact shape below the emitter electrode from comb type to the new mesh type. As a result, the saturation voltage ($V_{CE(sat)}$) and fall time (t_f) have both been reduced, thus reducing switching loss.

5

Comparison of Product Characteristic Curve, Features and Emitter-Contact Design

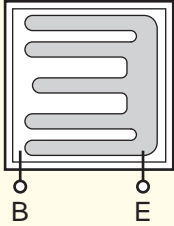
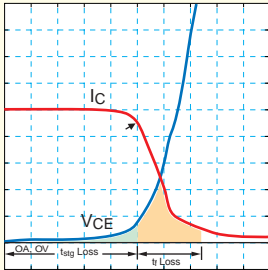
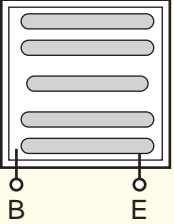
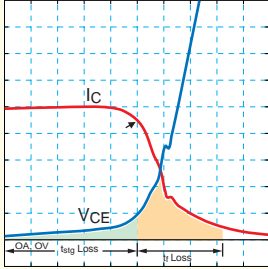
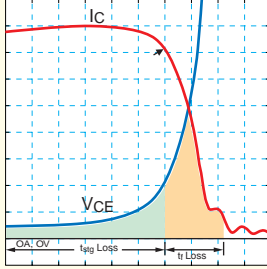
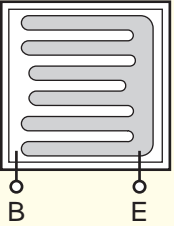
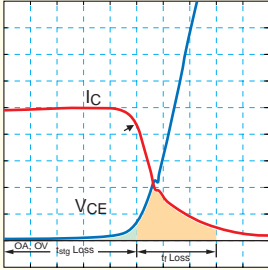
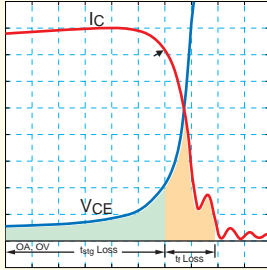
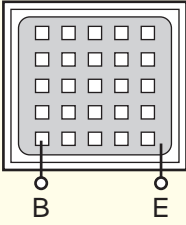
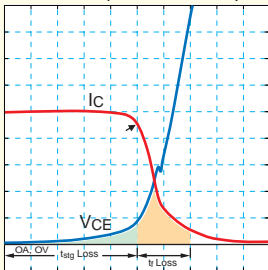
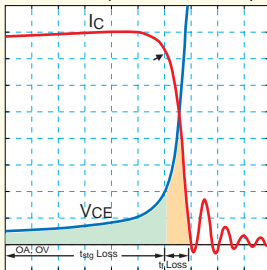
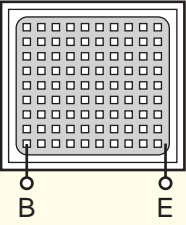
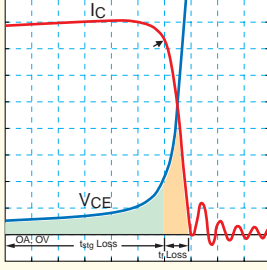
Generation	Design	Typical Products and Waveforms	
	Emitter contact shape	TVs	Video displays
	@f _H , I _{CP} , I _{B1} (end), V _{CP} (t, I _C , V _{CE}) / div	@15.75kHz, 5A, 1A, 1200V (200ns, 1A, 10v) / div	@100kHz, 8A, 1A, 1200V (50ns, 1A, 10v) / div
First Generation <ul style="list-style-type: none"> TVs <ul style="list-style-type: none"> High-voltage → 1500 V Improved R-SOA Improved switching speeds f_H(max) = 32 kHz Development of TO-3P(H)IS Package 	Comb type I 	2SD1556 (1500 V / 6A) 	
Second Generation <ul style="list-style-type: none"> TVs <ul style="list-style-type: none"> High-current devices products Video displays <ul style="list-style-type: none"> Improved switching speeds f_H(max) = 64 kHz Development of TO-3P(LH) Package 	STRIPE type 	2SD2253 (1700 V / 6A) 	2SC4290A (1500 V / 20A) 
Third Generation <ul style="list-style-type: none"> TVs <ul style="list-style-type: none"> Improvements over first-generation products Video displays <ul style="list-style-type: none"> Improvements over second-generation products Improved switching speeds f_H(max) = 80 kHz 	Comb type II 	2SD2553 (1700 V / 8A) 	2SC5142 (1500 V / 20A) 
Fourth Generation <ul style="list-style-type: none"> TVs <ul style="list-style-type: none"> Improvements over first- and third-generation products Digital TVs <ul style="list-style-type: none"> Development of new 2000-V products Video displays <ul style="list-style-type: none"> Improvements over third-generation products Improved switching speeds f_H(max) = 130 kHz 	Mesh type I or Crystal-mesh type 	2SD2638 (1700 V / 7A) 	2SC5445 (1500 V / 20A) 
Fifth Generation <ul style="list-style-type: none"> Digital TVs <ul style="list-style-type: none"> Enhanced 2000-V product line Improved speeds for products incorporating damper diodes Video displays <ul style="list-style-type: none"> Improvements over fourth-generation products Reduced loss Improvement in drivability 	Mesh type II 		2SC5695 (1500 V / 22A) 

6 New Products

1 For video displays

Product No.	Maximum Ratings			Target Use	Remarks	Note
	V _{CB0} (V)	I _C (A)	P _C (W)			
2SC5570	1700	28	220	21-inch, 130 kHz	Device with highest I _C (max) ratings	
2SC5587	1500	17	75	19-inch, 110 kHz	High-current version of 2SC5411	
2SC5588	1700	15	75	19-inch, 90 kHz	1700-V version of 2SC5411	
2SC5589	1500	18	200	19-inch, 120 kHz	2SC5587 and 2SC5589 use same chip.	
2SC5590	1700	16	200	19-inch, 100 kHz	2SC5588 and 2SC5590 use same chip.	
2SC5695	1500	22	200	21-inch, 130 kHz	Equivalent to 2SC5445	
2SC5717	1500	21	75	19-inch, 120 kHz	2SC5717 and 2SC5695 use same chip.	
*(S3D20)	1500	14	55	19-inch, 92 kHz	Equivalent to 2SC5411	★
*(S3D21)	1700	28	210	21-inch, 130 kHz	Equivalent to 2SC5570	★

★: Production schedules are provisional.

2 For color TVs

Product No.	Maximum Ratings			Target Use	Remarks	Note
	V _{CB0} (V)	I _C (A)	P _C (W)			
2SD2638	1700	7	50	28-inch, 15.75 kHz	Equivalent to 2SD2553	

3 For digital TVs

Product No.	Maximum Ratings			Target Use	Remarks	Note
	V _{CB0} (V)	I _C (A)	P _C (W)			
2SC5570	1700	28	220	32-inch, 32 kHz~	Device with highest I _C (max) ratings	
2SC5588	1700	15	50	24-inch, 32 kHz	1700-V version of 2SC5411	
2SC5590	1700	16	50	28-inch, 32 kHz~	2SC5588 and 2SC5590 use same chip.	
2SC5612	2000	22	220	32-inch, 32 kHz	V _{CB0} = 2000 V series	
2SC5716	1700	8	55	32-inch, 32 kHz	Built-in damper diode (High-current version of 2SC5143)	
*(2SC5748)	2000	16	210	32-inch, 32 kHz	V _{CB0} = 2000 V series	★
*(2SC5749)	2000	16	210	32-inch, 32 kHz	V _{CB0} = 2000 V series (built-in damper diode)	★
*(S3D21)	1700	28	210	32-inch, 32 kHz~	Equivalent to 2SC5570	★

★: Production schedules are provisional.

7 Product Line Matrix

Package	V _{CB0} = 1500 V			V _{CB0} = 1700 V			V _{CB0} = 2000 V	
	TO-3P(H)IS		TO-3P(LH)	TO-3P(H)IS		TO-3P(LH)	TO-3P(LH)	
	40 W to 75 W		180 W to 220 W	40 W to 75 W		180 W to 220 W	180 W to 220 W	
P _C	Built-in damper diode	No built-in damper diode	No built-in damper diode	Built-in damper diode	No built-in damper diode	No built-in damper diode	Built-in damper diode	No built-in damper diode
**I _C (sat)								
3 A	2SD2599			2SD2550				
3.5 A	2SD2586							
4 A	2SD2499	2SD2498		2SD2551				
4.5 A	S2055N	S2000N						
5 A	2SD2539							
	2SC5339							
5.5 A				2SD2638				
6 A	2SC5280	2SD2500		2SD2553				
	2SD2559	2SC5386		2SC5716				
7 A		2SC5404						
8 A		2SC5387						
11 A		2SC5411	2SC5421			2SC5422		
		*(S3D20)						
12 A					2SC5588	2SC5590	*(2SC5749)	*(2SC5748)
14 A		2SC5587	2SC5589			2SC5446		
15 A			2SC5445					
17 A		2SC5717	2SC5695					2SC5612
22 A						2SC5570		
						*(S3D21)		

Notes: **: I_C(sat) is value of I_C for V_{CE}(sat).

- : 3rd generation (old design)
- : 4th generation (new design)
- : 5th generation (new design)
- : 5th generation (new design under development)

8

Characteristics List

1 2SC Series

Product No.	Maximum Ratings			Built-in damper diode	h _{FE}			V _{CE(sat)} Max			Switching Time (Max)				Generation
	V _{CB0} (V)	I _C (A)	P _C (W)		Min (-)	Max (-)	@5V/I _C (A)	(V)	@ I _C (A)	@ I _B (A)	t _{stg} (μs)	t _f (μs)	@ f _H (kHz)	@ I _{cp} (A)	
2SC5280	1500	8	50	✓	4.0	8.5	6	5	6	1.5	6.0	0.50	32	6.0	4th
2SC5339	1500	7	50	✓	4.0	8.0	5	5	5	1.25	6.0	0.50	32	5.0	4th
2SC5386	1500	8	50		4.3	7.5	6	3	6	1.5	3.5	0.30	64	5.0	4th
2SC5387	1500	10	50		4.3	7.8	8	3	8	2	3.5	0.30	64	6.0	4th
2SC5404	1500	9	50		4.0	8.0	7	3	7	1.75	3.5	0.30	64	5.5	4th
2SC5411	1500	14	60		4.0	8.0	11	3	11	2.75	3.5	0.30	64	8.5	4th
2SC5421	1500	15	180		4.0	8.0	11	3	11	2.75	3.5	0.30	64	8.5	4th
2SC5422	1700	15	200		4.5	8.5	11	3	11	2.75	3.5	0.30	64	8.0	4th
2SC5445	1500	20	200		4.5	8.5	15	3	15	3.75	2.2	0.15	100	8.0	4th
2SC5446	1700	18	200		4.0	8.0	14	3	14	3.5	2.3	0.15	100	7.0	4th
2SC5570	1700	28	200		4.5	7.5	22	3	22	5.5	1.6	0.15	130	8.0	4th
2SC5587	1500	17	75		5.0	8.0	14	3	14	3.5	2.0	0.15	100	7.5	4th
2SC5588	1700	15	75		4.8	8.0	12	3	12	3	2.0	0.15	100	6.5	4th
2SC5589	1500	18	200		5.0	8.0	14	3	14	3.5	2.0	0.15	100	7.5	4th
2SC5590	1700	16	200		4.8	8.0	12	3	12	3	2.0	0.15	100	6.5	4th
2SC5612	2000	22	220		4.8	9.0	17	3	17	4.25	5.0	0.35	32	8.0	4th
2SC5695	1500	22	200		4.5	8.5	17	3	17	3.75	2.1	0.15	100	8.0	5th
2SC5716	1700	8	55	✓	3.8	9.0	6	5	6	1.5	5.0	0.35	32	5.5	4th
2SC5717	1500	21	75		4.5	8.5	17	3	17	3.75	2.1	0.15	100	8.0	5th
*(2SC5748)	2000	16	210		4.8	7.5	12	3	12	3	5.0	0.35	32	8.0	5th
*(2SC5749)	2000	16	210	✓	4.8	9.0	12	3	12	3	5.0	0.35	32	8.0	5th
*(S3D20)	1500	14	55		4.0	8.0	11	3	11	2.75	3.5	0.30	90	6.5	5th
*(S3D21)	1700	28	210		4.5	7.5	22	3	22	5.5	1.6	0.15	130	8.0	5th

2 2SD Series

Product No.	Maximum Ratings			Built-in damper diode	h _{FE}			V _{CE(sat)} Max			Switching Time (Max)				Generation
	V _{CB0} (V)	I _C (A)	P _C (W)		Min (-)	Max (-)	@5V/I _C (A)	(V)	@ I _C (A)	@ I _B (A)	t _{stg} (μs)	t _f (μs)	@ f _H (kHz)	@ I _{cp} (A)	
2SD2498	1500	6	50		5	9	4	5	4	0.8	10	0.7	15.75	4	3rd
2SD2499	1500	6	50	✓	5	9	4	5	4	0.8	11	0.6	15.75	4	3rd
2SD2500	1500	10	50		4	8	6	3	6	1.5	11	0.7	15.75	6	3rd
2SD2539	1500	7	50	✓	5	9	5	5	5	1	9	0.6	15.75	5	3rd
2SD2550	1700	4	50	✓	8	22	1	8	3	0.8	10	0.6	15.75	3	3rd
2SD2551	1700	5	50	✓	5	10	4	5	4	0.8	10	1.0	15.75	4	3rd
2SD2553	1700	8	50	✓	5	9	6	5	6	1.2	12	0.7	15.75	6	3rd
2SD2559	1500	8	50	✓	5	9	6	5	6	1.2	12	1.0	15.75	6	4th
2SD2586	1500	5	50	✓	4.4	8.5	3.5	5	3.5	0.8	10	0.6	15.75	3.5	4th
2SD2599	1500	3.5	40	✓	8	25	0.5	8	3	0.8	10	1.0	15.75	3	4th
2SD2638	1700	7	50	✓	4.5	7.5	5.5	5	5.5	1.2	9	0.8	15.75	5.5	4th

3 S2000 / S2055 Series

Product No.	Maximum Ratings			Built-in damper diode	h _{FE}			V _{CE(sat)} Max			Switching Time (Max)				Generation
	V _{CB0} (V)	I _C (A)	P _C (W)		Min (-)	Max (-)	@5V/I _C (A)	(V)	@ I _C (A)	@ I _B (A)	t _{stg} (μs)	t _f (μs)	@ f _H (kHz)	@ I _{cp} (A)	
S2000N	1500	8	50		4.5	9	4.5	5	4.5	1	12	0.7	15.75	4.5	3rd
S2055N	1500	8	50	✓	4.5	9	4.5	5	4.5	1	11	0.6	15.75	4.5	3rd

■ : 3rd generation (old design)

■ : 4th generation (new design)

■ : 5th generation (new design)

■ : 5th generation (new design under development)

Generations

Example **2SDXXXX** : 3rd Gen. (old design)
2SCXXXX : 4th Gen. (new design)

2SCXXXX : 5th Gen. (new design)
***(2SCXXXX)** : under development

1 2SC Series

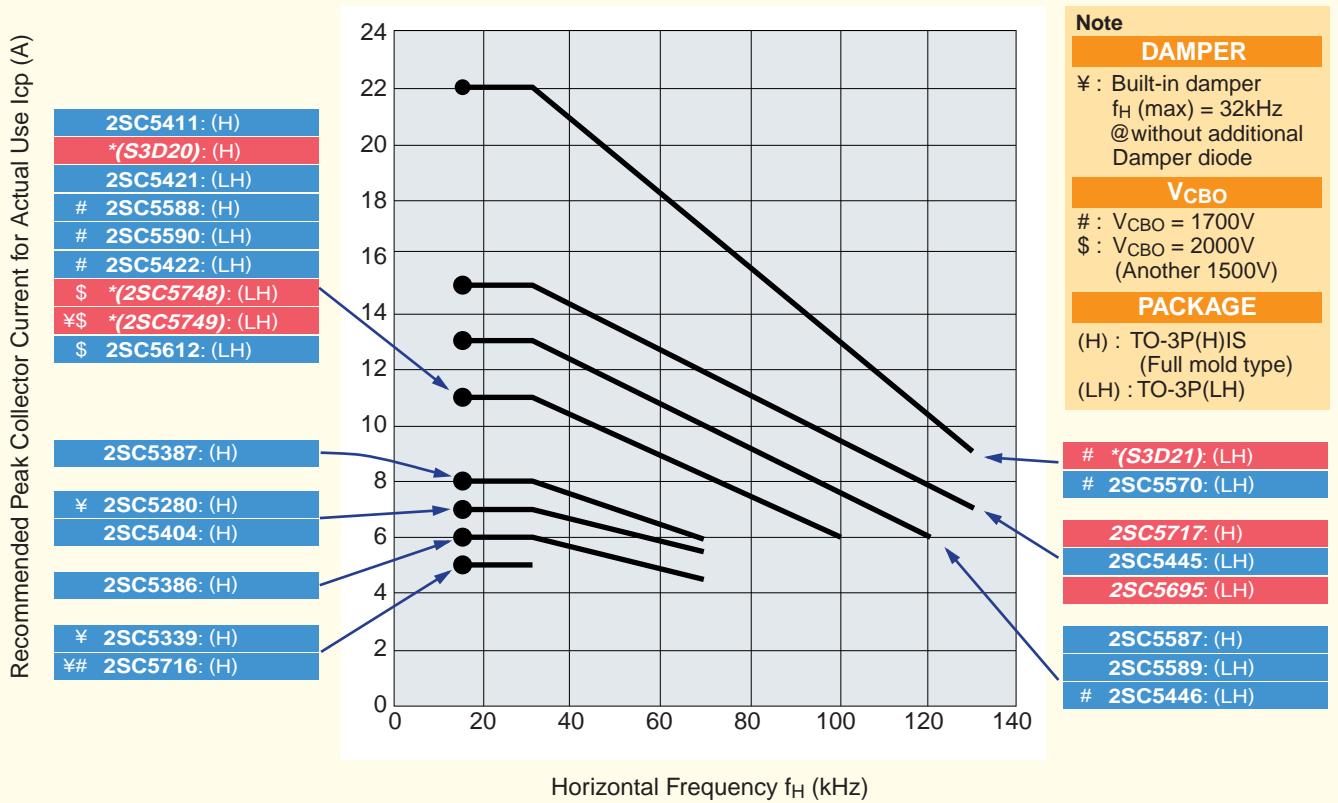

2 2SD / S2000 / S2055 Series

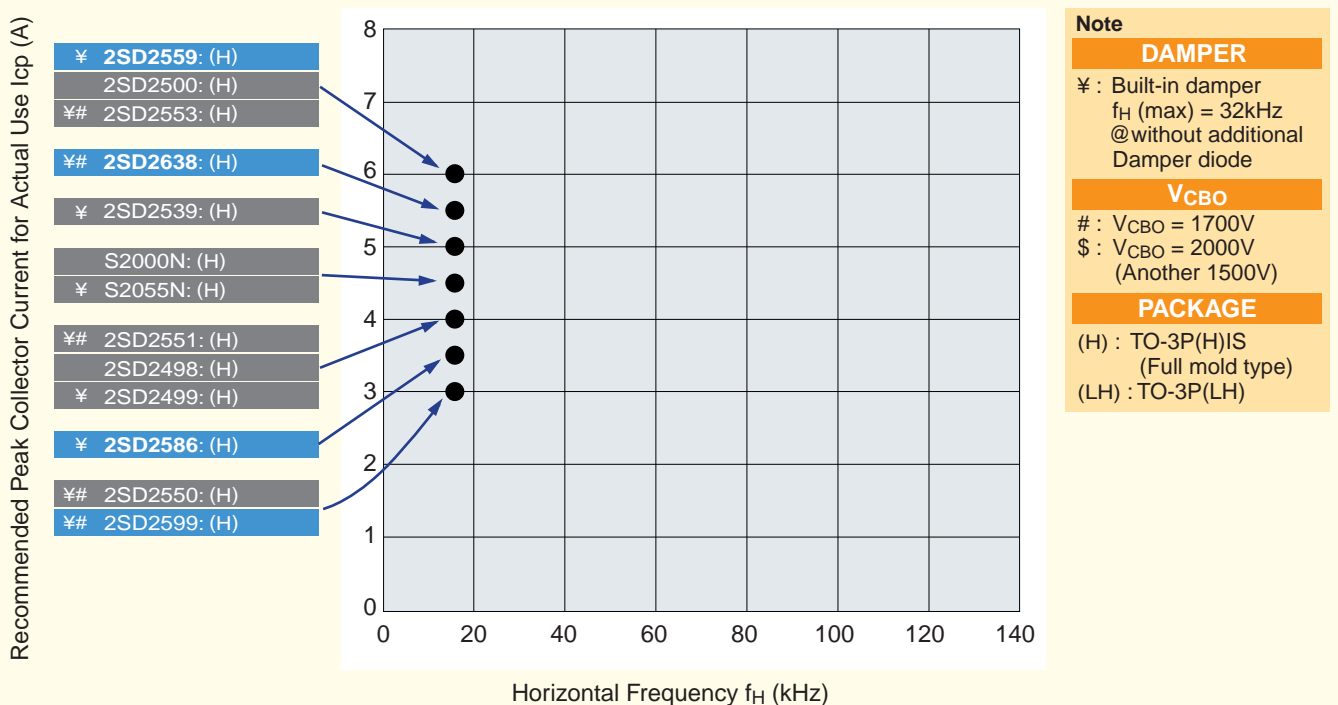

Measurement conditions

$f_H = 69 \text{ kHz}$ (duty 50%)
 $I_{CP} = 5 \text{ A}$
 $V_{CP} = 1200 \text{ V}$

Basic circuit structure

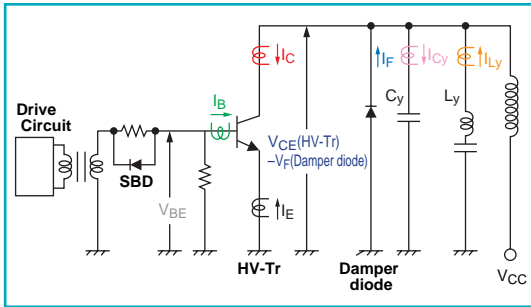

Measurement range

X-axis

t (time) $2\mu\text{s} / \text{div}$

Y-axis

V_{BE} (Base-emitter voltage) $5\text{V} / \text{div}$

I_B (Base current) $2\text{A} / \text{div}$

I_C (Collector current) $2\text{A} / \text{div}$

$-I_E$ (Reverse emitter current) $2\text{A} / \text{div}$

I_F (Forward current) $2\text{A} / \text{div}$

V_{CE} (Collector-emitter voltage) $200\text{V} / \text{div}$

I_{LY} (Deflection coil current) $2\text{A} / \text{div}$

I_{CY} (Resonance capacitor current) $2\text{A} / \text{div}$

Enlarged wave forms of I_B and I_C

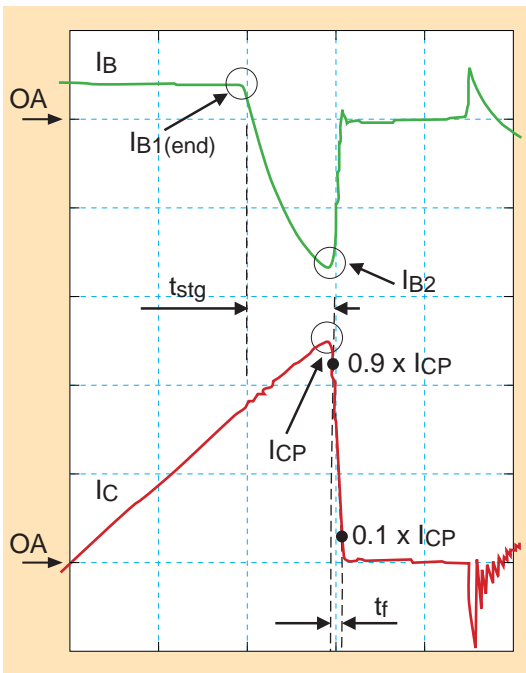

Main operations



Operating waveform example

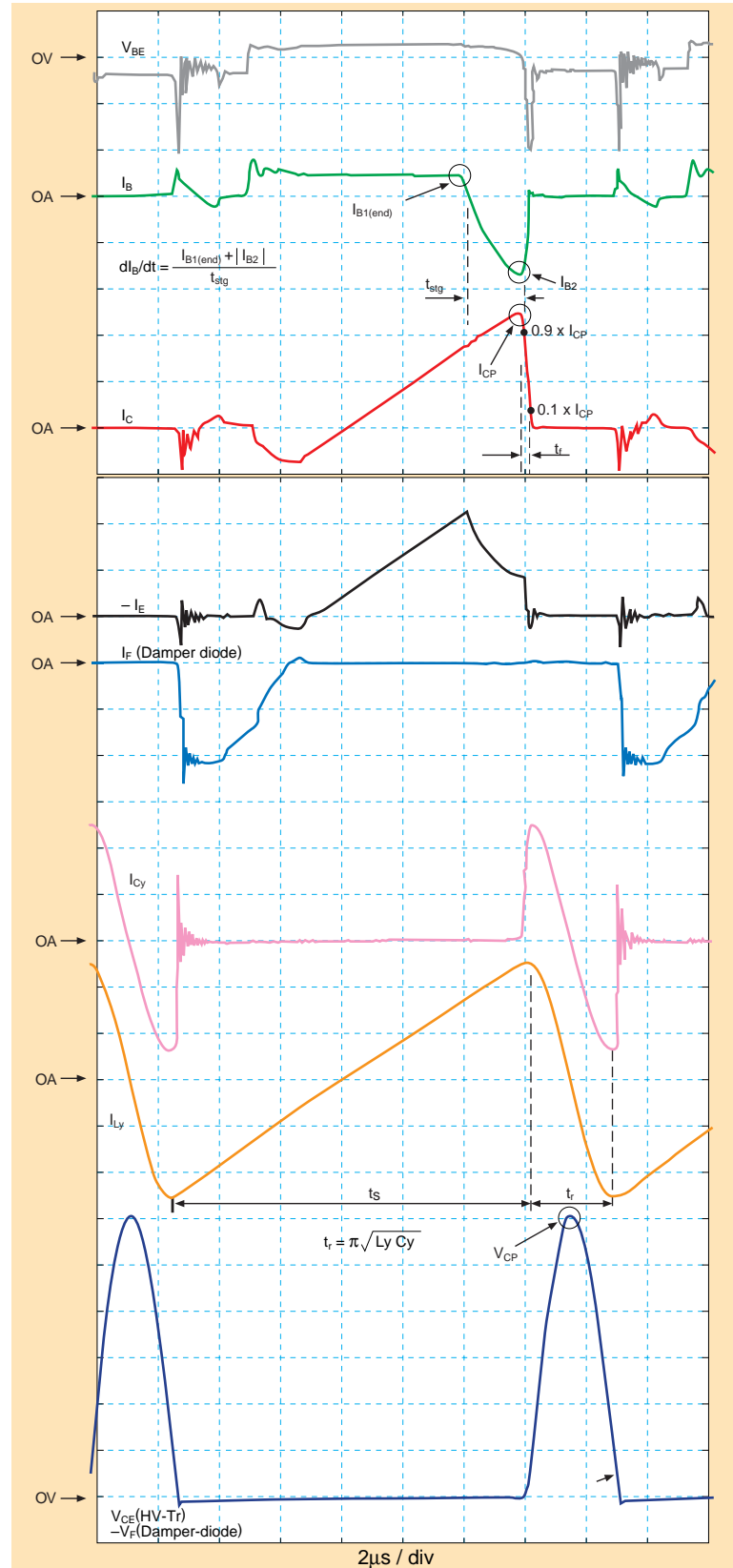

11 Switching Data of 2SC5695

(Reference only)

1 Test condition

@ $T_C \cong 25^\circ\text{C}$

$f_H = 105\text{ kHz}$ (duty 50%, continuous operation)

$I_{CP} = 6.5\text{ A} \rightarrow V_{CP} \cong 953\text{V}$ ($V_{CC2} \cong 107\text{V}$)

$I_{CP} = 8.5\text{ A} \rightarrow V_{CP} \cong 1220\text{V}$ ($V_{CC2} \cong 140\text{V}$)

$-dI_B / dt \cong 4.0\text{A}/\mu\text{s}$ ($V_{CC1} = 24\text{V}$)

$L_y = 63\ \mu\text{H}$, $C_y = 4000\ \text{pF}$

2 Test sample

Mark		Test Sample	hFE (1)		hFE (2)		hFE (3)		VCE (sat)
$I_{CP} = 6.5\text{ A}$	$I_{CP} = 8.5\text{ A}$		@5V / 2A	@5V / 10A	@5V / 10A	@5V / 17A	@5V / 17A	@17A / 4.25A	
		Standard spec.	20 (min) 50 (max)	8 (min) 17 (max)	4.8 (min) 8.3 (max)			3V (max)	
○---○	○---○	tail side	50.5	15.6	8.2			0.4V	
△---△	△---△	Typ	33.8	12.1	6.6			0.6V	
×---×	×---×	storage side	24.1	8.2	4.6			2.9V	

3 tstg, t_f , $-dI_B / dt$, SW loss — I_{B1} (end)

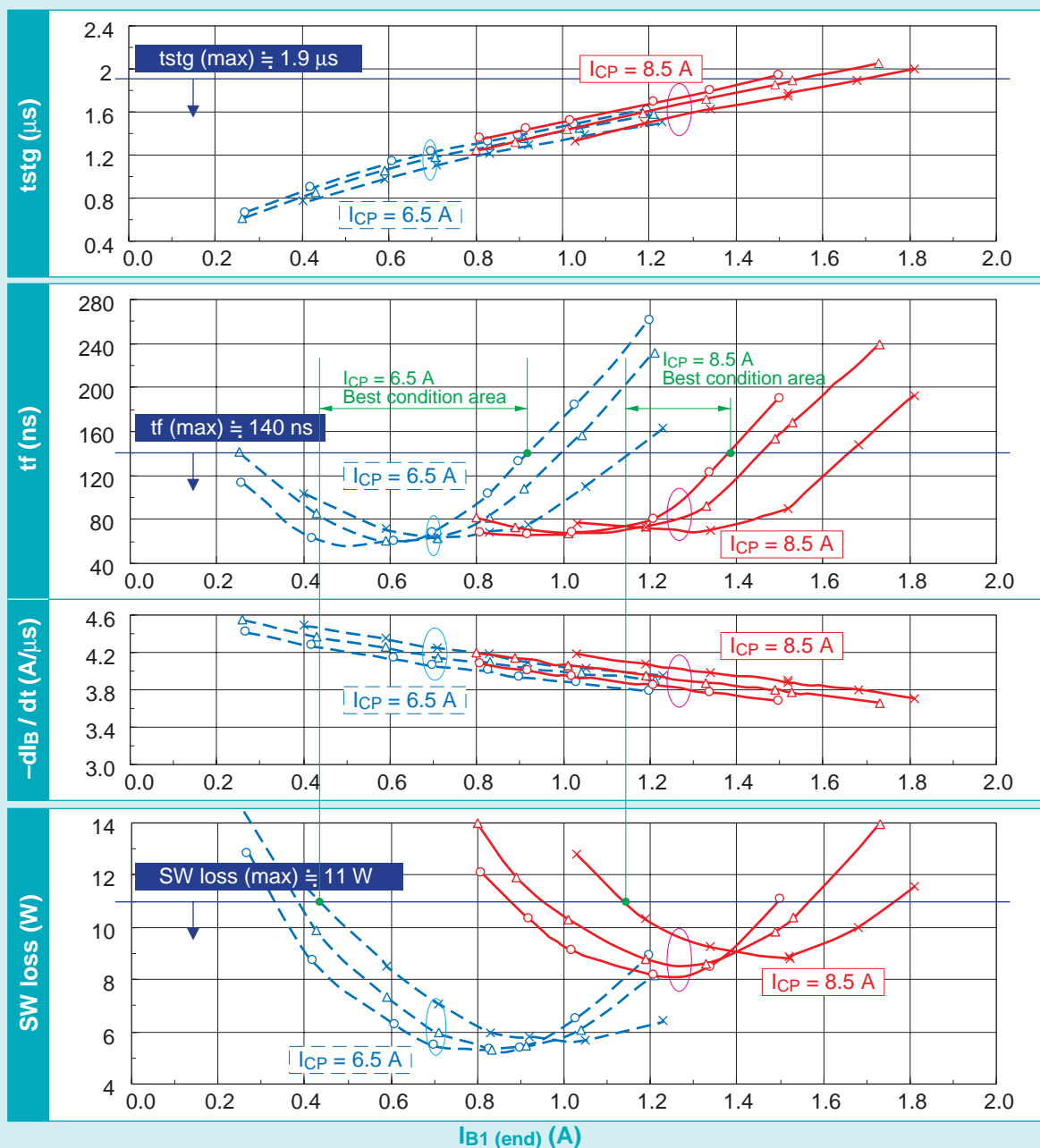

4 Recommended values (rough calculation)

tstg (max)

$$tstg (max) = (1/f_H) \times 0.2$$

$$tstg (max) \approx 1.9 \mu s$$

tf (max)

$$tf (max) = (1/f_H) \times 0.01 + 50 ns$$

$$tf (max) \approx 140 ns$$

Switching loss capacitance (max)

@ Ta (max) = 40°C, Tj (max) = 110°C Recommended
 $\Delta Tj (max) = 110^\circ C - 40^\circ C$
 $\rightarrow \Delta Tj (max) = 70^\circ C$ Recommended

thermal resistance

junction to case: Rth (j-c) = 0.625°C/W (2SC5695)
 case to fin (heat-sink): Rth (c-f) = 1°C/W (supposition)
 +) fin (heat-sink) to air: Rth (f-a) = 3.5°C/W (supposition)

TOTAL (junction on ari): Rth (f-a) = 5.125°C/W

SW Loss Capacitance (max) = $\Delta Tj (max) / Rth (j-a) \times 80\%$ derating
 = $70 / 5.125 \times 0.8$
 = 10.9

$$SW \text{ loss Capacitance (max)} \approx 11 W$$

Application Circuit Example of 2SC5695

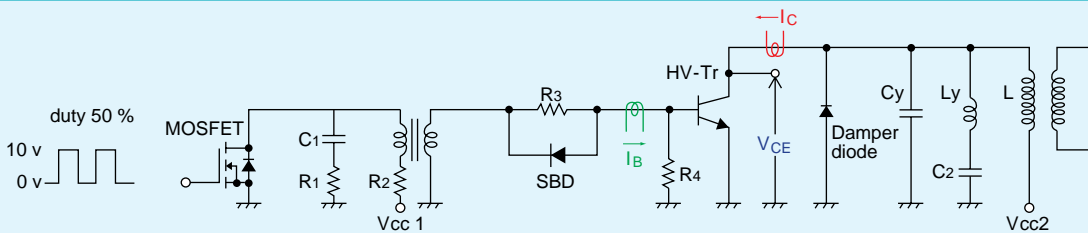

Semiconductors devices

- MOSFET : 2SK2146
- SBD : 3GWJ42C
- HV-Tr : 2SC5695
- Damper diode : 5TUZ52

Others

- Vcc1 \approx 15 V
- Vcc2 \approx (47 V (@ 32 kHz)
156 V (@ 100 kHz))
- Cy = 4500 pF
- Ly = 80 μ H

- R1 = 200 Ω
- R2 = 3 Ω
- R3 = 1.85 Ω
- R4 = 15 Ω
- C1 = 200 pF
- C2 = 3.3 μ F
- L = 10 mH

Operating waveform example (21-inch ultra-high-resolution monitor) f_H = 32 kHz to 100 kHz monitor

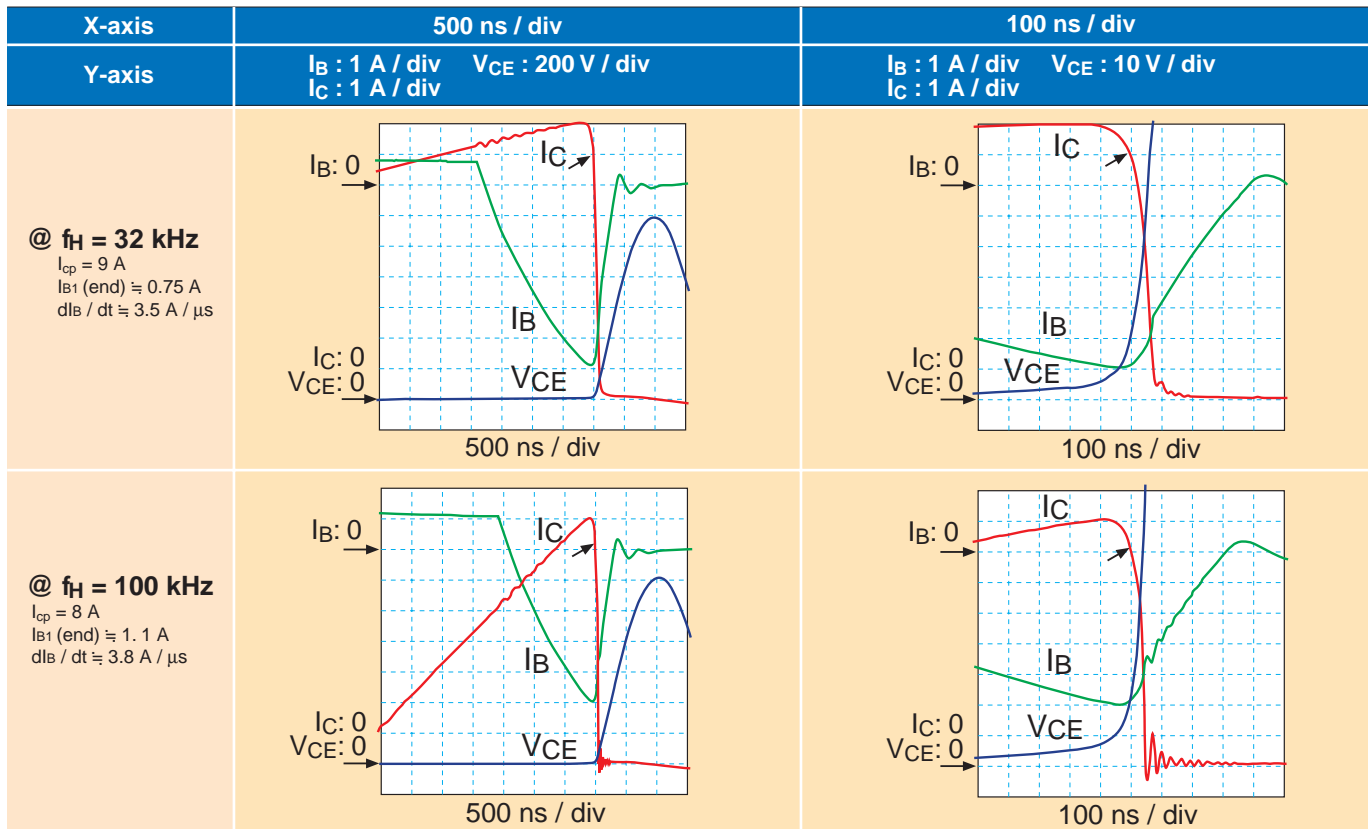

13 Lead-Forming

● TO-3P(H)IS

(Unit : mm)

2-16E302A

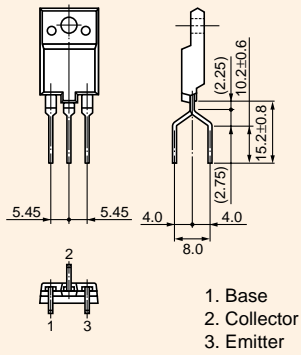

2-16E303A

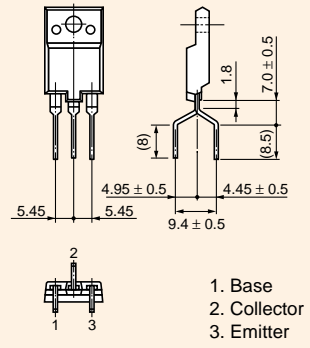

2-16E305A

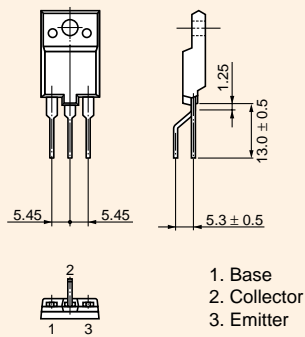

2-16E306A

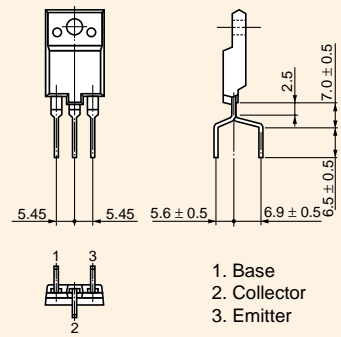

2-16E307A

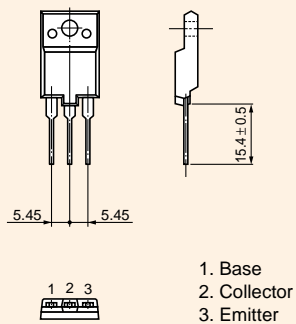

2-16E309A

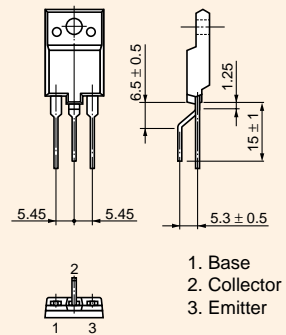

2-16E311A

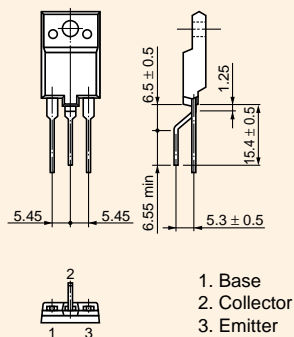

2-16E313A

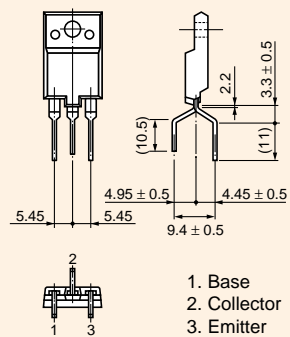

TO-3P(H)IS

(Unit : mm)

2-16E314A

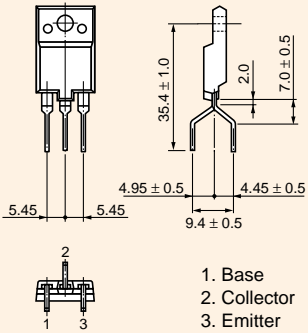

2-16E315A

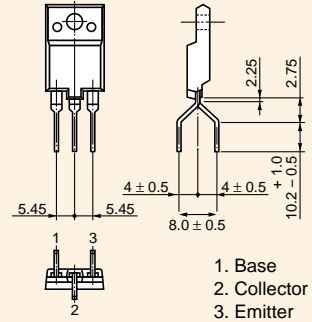

2-16E316A

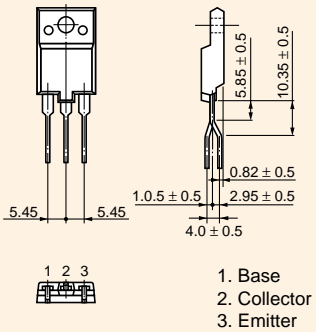

TO-3P(LH)

(Unit : mm)

2-21F208A

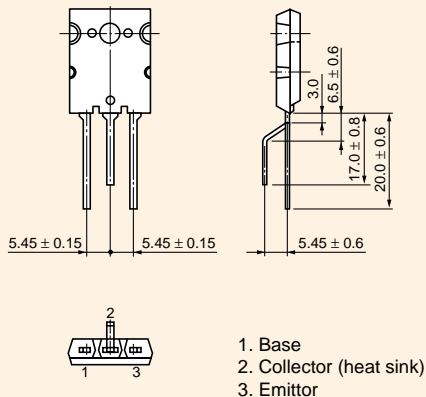

2-21F218A

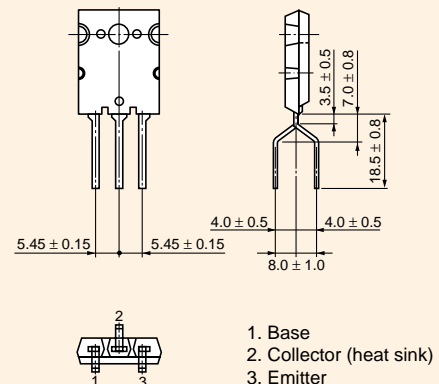

14 Markings

(As of April 2001)

● Explanation of markings

Toshiba horizontal-deflection output transistors are manufactured in Japan (at the Himeji Semiconductor Works) and in Malaysia (at Toshiba Electronics Malaysia Sdn. Bhd.). Toshiba Electronics Malaysia Sdn. Bhd. only manufactures TO-3P(H)IS products.

Place of Manufacture	TOSHIBA ELECTRONICS MALAYSIA SDN. BHD (made in Malaysia)	Himeji Semiconductor Works (made in Japan)
Package type	TO-3P(H)IS	TO-3P(LH)
Marking Example		
Definition	<p>*1: Manufacturer's marking: "T", "TOSHIBA" *2: Product number or abbreviated product number *3: Code: "1", "2", "3", "A", "B", "C" *4: Lot number: month and year of manufacture Month of manufacture: January to December are denoted by the letters A to L respectively. Year of manufacture: last decimal digit of year of manufacture "1A", as shown on the above package, indicates manufacture in January 2001. *5: Country of origin Since TO-3P(LH) packages are only made in Japan, "JAPAN" is displayed.</p>	

15 Package Label

(As of April 2001)

● Sample label

P/N:			
TYPE			
ADDC		Q'TY	PCS.
NOTE			
TOSHIBA		MADE IN JAPAN	

16 Package Specifications

(As of April 2001)

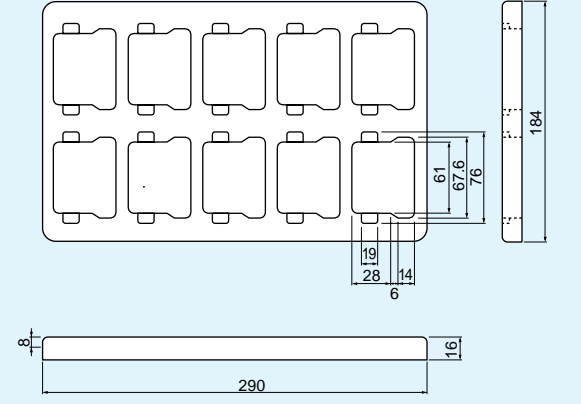
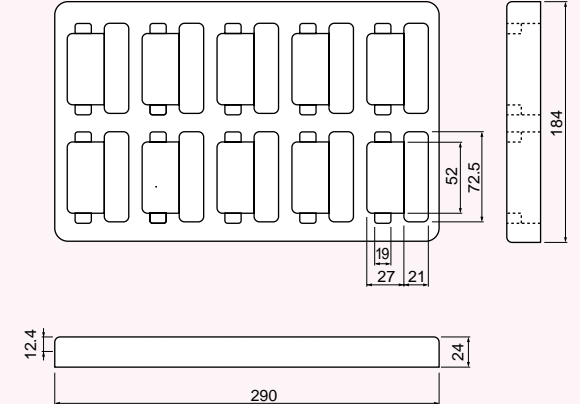
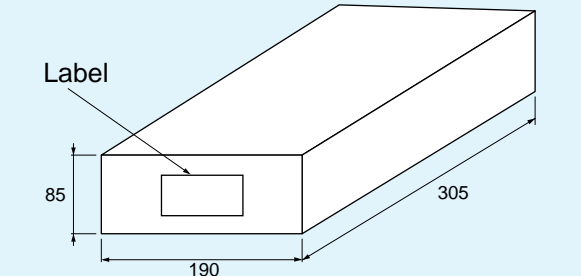
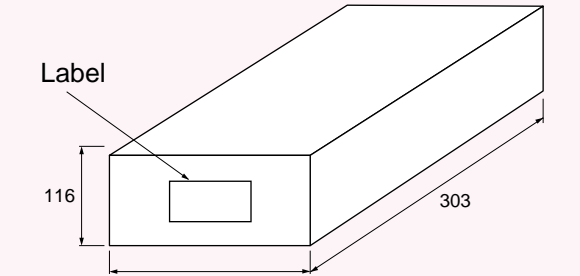
Package type	TO-3P(H)IS	TO-3P(LH)
Packing Type	100 per tray, 5 trays per carton	
Tray Dimensions (unit: mm)	<p>Tolerance: ± 0.7 Material: rigid vinyl chloride</p>  <p>Diagram showing a tray with 10 components arranged in two rows of five. Dimensions include: overall length 290 mm, overall width 184 mm, component width 61 mm, component height 67.6 mm, component spacing 76 mm, component offset 19 mm, component width offset 28 mm, component width offset 14 mm, and component width offset 6 mm.</p>	<p>Tolerance: ± 0.7 Material: rigid vinyl chloride</p>  <p>Diagram showing a tray with 10 components arranged in two rows of five. Dimensions include: overall length 290 mm, overall width 184 mm, component width 52 mm, component height 72.5 mm, component spacing 27 mm, component offset 19 mm, component width offset 21 mm, and component width offset 24 mm.</p>
Carton Dimensions (unit: mm)	 <p>Diagram showing a carton with dimensions: height 85 mm, width 190 mm, and length 305 mm. A label is indicated on the front face.</p>	 <p>Diagram showing a carton with dimensions: height 116 mm, width 190 mm, and length 303 mm. A label is indicated on the front face.</p>

1 2SC Series

Product No.	Super-seded Products	Final Phase Products	Discon- tinued Products	Maximum Ratings			Built-in damper diode	V _{CE(sat)} (V)			Package Type				* Recommended Replacement and Remarks
				V _{CBO} (V)	I _C (A)	P _C (W)		Max	@ I _C (A)	@ I _B (A)	(H)IS	(BS)	(LH)	TO-3	
2SC3715			✓	1500	4	50		5	2.5	0.6	✓				2SD2599; ②
2SC3716			✓	1500	5	50		5	3	0.8	✓				2SD2599; ①
2SC3884A			✓	1500	6	50		5	4	1	✓				2SC5386; ②
2SC3885A			✓	1500	7	50		5	5	1.2	✓				2SC5386; ②
2SC3886A			✓	1500	8	50		5	6	1.5	✓				2SC5386; ②
2SC3887			✓	1400	6	80		5	4	1		✓			2SC5386; ② ⑤
2SC3887A			✓	1500	6	80		5	4	1		✓			2SC5386; ② ⑤
2SC3888			✓	1400	7	80		5	5	1.2		✓			2SC5386; ② ⑤
2SC3888A			✓	1500	7	80		5	5	1.2		✓			2SC5386; ② ⑤
2SC3889			✓	1400	8	80		5	6	1.5		✓			2SC5386; ⑤
2SC3889A			✓	1500	8	80		5	6	1.5		✓			2SC5386; ⑤
2SC3892			✓	1400	7	50	✓	5	5	1.2	✓				2SC5339; ①
2SC3892A			✓	1500	7	50	✓	5	5	1.2	✓				2SC5339; ①
2SC3893			✓	1400	8	50	✓	5	6	1.5	✓				2SC5280; ①
2SC3893A			✓	1500	8	50	✓	5	6	1.5	✓				2SC5280; ①
2SC4288			✓	1400	12	200		5	10	2.5			✓		2SC5421; ⑤
2SC4288A			✓	1500	12	200		5	10	2.5			✓		2SC5421; ⑤
2SC4289			✓	1400	16	200		5	12	3			✓		2SC5589; ②
2SC4289A			✓	1500	16	200		5	12	3			✓		2SC5589; ②
2SC4290			✓	1400	20	200		5	14	3.5			✓		2SC5589; ②
2SC4290A			✓	1500	20	200		5	14	3.5			✓		2SC5589; ②
2SC4531			✓	1500	10	50	✓	5	7	1.7	✓				2SC5280; ③
2SC4532			✓	1700	10	200		5	8	2			✓		2SC5422; ②
2SC4542			✓	1500	10	50		5	7	1.7	✓				2SC5404; ①
2SC4560			✓	1500	10	80		5	7	1.7		✓			2SC5404; ⑤
2SC4608			✓	1700	8	200		5	6	1.5			✓		2SC5422; ②
2SC4757			✓	1500	7	50		5	5	1.2	✓				2SC5386; ②
2SC4758			✓	1500	8	50		5	6	1.5	✓				2SC5386; ①
2SC4759			✓	1500	10	50		5	7	1.7	✓				2SC5404; ①
2SC4760		✓		2000	8	200		5	6	1.5			✓		2SC5612; ②
2SC4761			✓	1700	6	50		5	4.5	1.3	✓				2SC5588; ②
2SC4762			✓	1500	7	50	✓	5	5	1	✓				2SC5280; ①
2SC4763			✓	1500	8	50	✓	5	6	1.2	✓				2SC5280; ③
2SC4764			✓	1500	6	50	✓	5	4	0.8	✓				2SC5339; ②
2SC4765			✓	1700	5	50	✓	5	3.5	1	✓				2SC5716; ②
2SC4766			✓	1700	6	50	✓	5	4.5	1.3	✓				2SC5716; ②
2SC4806			✓	1700	5	50		5	3.5	1	✓				2SC5588; ②
2SC4830			✓	1500	6	50		5	4	1	✓				2SC5386; ②
2SC4916			✓	1500	7	50	✓	5	5	1	✓				2SC5280; ①
2SC5048	✓			1500	12	50		3	8	2	✓				2SC5387; ①
2SC5129	✓			1500	10	50		3	6	1.5	✓				2SC5386; ①
2SC5142		✓		1500	20	200		3	14	3.5			✓		2SC5589; ①
2SC5143	✓			1700	10	50	✓	3	6	1.5	✓				2SC5716; ③
2SC5144	✓			1700	20	200		3	11	2.75			✓		2SC5590; ①
2SC5148	✓			1500	12	50		3	8	2	✓				2SC5386; ②
2SC5149		✓		1500	8	50	✓	5	5	1.3	✓				2SC5339; ①
2SC5150	✓			1700	10	50		3	6	1.5	✓				2SC5588; ②
2SC5331	✓			1500	15	180		3	9	2.25			✓		2SC5421; ②
2SC5332		✓		1700	14	200		3	8	2			✓		2SC5422; ②

- (*) ① Electrical characteristics and packages are same.
 ② Electrical characteristics have are high grade.
 ③ Electrical characteristics are low grade.
 ④ Package (allowable power dissipation) are high grade.
 ⑤ Package (allowable power dissipation) are low grade.
 ⑥ Damper diode is built-in or not.

Notes: : 1st generation
 : 2nd generation (final-phase or discontinued products)
 : 3rd generation (old design superseded products)
 : 4th generation (new design)

2 2SD Series

Product No.	Super-seeded Products	Final Phase Products	Discontinued Products	Maximum Ratings			Built-in damper diode	V _{CE(sat)} (V)			Package Type				* Recommended Replacement and Remarks
				V _{CBO} (V)	I _C (A)	P _C (W)		Max	@ I _C (A)	@ I _B (A)	(H)IS	(BS)	(LH)	TO-3	
2SD811			✓	900	6	50		10	2.5	0.25				✓	2SC3657; ⑤
2SD818			✓	1500	2.5	50		8	2	0.6				✓	2SD2599; ⑥
2SD819			✓	1500	3.5	50		8	3	0.8				✓	2SD2599; ⑥
2SD820			✓	1500	5	50		5	4	0.8				✓	2SC5386; ②
2SD821			✓	1500	6	50		5	5	1				✓	2SC5386; ②
2SD822			✓	1500	7	50		5	6	1.2				✓	2SC5386; ②
2SD868			✓	1500	2.5	50	✓	8	2	0.6				✓	2SD2599; ② ⑤
2SD869			✓	1400	3.5	50	✓	8	3	0.8				✓	2SD2599; ⑤
2SD870			✓	1500	5	50	✓	5	4	0.8				✓	2SD2499; ①
2SD871			✓	1500	6	50	✓	5	5	1				✓	2SD2539; ①
2SD1279			✓	1400	10	50		5	8	2				✓	2SC5404; ①
2SD1425			✓	1500	2.5	80	✓	8	2	0.6		✓			2SD2599; ② ⑥
2SD1426			✓	1500	3.5	80	✓	8	3	0.8		✓			2SD2599; ⑤
2SD1427			✓	1500	5	80	✓	5	4	0.8		✓			2SD2499; ①
2SD1428			✓	1500	6	80	✓	5	5	1		✓			2SD2539; ⑤
2SD1429			✓	1500	2.5	80		8	2	0.6		✓			2SD2498; ⑤
2SD1430			✓	1500	3.5	80		8	3	0.8		✓			2SD2498; ⑤
2SD1431			✓	1500	5	80		5	4	0.8		✓			2SD2498; ⑤
2SD1432			✓	1500	6	80		5	5	1		✓			2SC5386; ⑤
2SD1433			✓	1500	7	80		5	6	1.2		✓			2SC5404; ⑤
2SD1543			✓	1500	2.5	40		8	2	0.6	✓				2SD2498; ②
2SD1544			✓	1500	3.5	40		8	3	0.8	✓				2SD2498; ②
2SD1545			✓	1500	5	50		5	4	0.8	✓				2SD2498; ①
2SD1546			✓	1500	6	50		5	5	1	✓				2SC5386; ①
2SD1547			✓	1500	7	50		5	6	1.2	✓				2SC5404; ①
2SD1548			✓	1500	8	50		5	8	2	✓				2SC5404; ①
2SD1553			✓	1500	2.5	40	✓	8	2	0.6	✓				2SD2599; ②
2SD1554			✓	1500	3.5	40	✓	8	3	0.8	✓				2SD2599; ①
2SD1555			✓	1500	5	50	✓	5	4	0.8	✓				2SD2499; ①
2SD1556			✓	1500	6	50	✓	5	5	1	✓				2SD2539; ①
2SD2089			✓	1500	3.5	40	✓	1	2.2	0.7	✓				2SD2599; ①
2SD2095			✓	1500	5	50	✓	5	3.5	0.8	✓				2SD2586; ①
2SD2125			✓	1500	6	50	✓	5	5	1	✓				2SD2539; ①
2SD2253			✓	1700	6	50	✓	5	5	1	✓				2SD2638; ①
2SD2348			✓	1500	8	50	✓	5	6	1.2	✓				2SC5280; ③
2SD2349			✓	1500	10	50	✓	5	7	1.4			✓		2SC5280; ③
2SD2428			✓	1700	8	200	✓	5	6	1.2	✓				2SD2553; ⑤
2SD2454			✓	1700	7	50	✓	5	6	1.2					2SD2638; ①

3 S2000 / S2055 Series

Product No.	Super-seeded Products	Final Phase Products	Discontinued Products	Maximum Ratings			Built-in damper diode	V _{CE(sat)} (V)			Package Type				* Recommended Replacement and Remarks
				V _{CBO} (V)	I _C (A)	P _C (W)		Max	@ I _C (A)	@ I _B (A)	(H)IS	(BS)	(LH)	TO-3	
S2000			✓	1500	5	80		5	4.5	2		✓			S2000N; ② ⑤
S2000A			✓	1500	5	80		1	4.5	2		✓			S2000N; ⑤
S2000AF			✓	1500	5	50		1	4.5	2	✓				S2000N; ①
S2000F			✓	1500	5	50		5	4.5	2	✓				S2000N; ②
S2055			✓	1500	5	80	✓	5	4.5	2		✓			S2055N; ② ⑥
S2055A			✓	1400	5	80	✓	1	4.5	2		✓			S2055N; ⑤
S2055AF			✓	1500	5	50	✓	1	4.5	2	✓				S2055N; ①
S2055F			✓	1500	5	50	✓	5	4.5	2	✓				S2055N; ②

- (*) ① Electrical characteristics and packages are same.
 ② Electrical characteristics have are high grade.
 ③ Electrical characteristics are low grade.
 ④ Package (allowable power dissipation) are high grade.
 ⑤ Package (allowable power dissipation) are low grade.
 ⑥ Damper diode is built-in or not.

Notes: : 1st generation
 : 2nd generation (final-phase or discontinued products)
 : 3rd generation (old design)
 : 4th generation (new design)

Package	V _{CB0} = \$900V, *1400V,1500 V							V _{CB0} = 1700 V			V _{CB0} = 2000 V		Package
	TO-3P(H)IS		TO-3		TO-3P(BS)		TO-3P(LH)	TO-3P(H)IS		TO-3P(LH)	TO-3P(LH)		
P _C max	40 W to 75 W		50 W		80 W		180 W to 220 W	40 W to 75 W		180 W to 220 W	180 W to 220 W		P _C max
**I _C (sat)	Built-in damper diode	No built-in damper diode	Built-in damper diode	No built-in damper diode	Built-in damper diode	No built-in damper diode	No built-in damper diode	Built-in damper diode	No built-in damper diode	No built-in damper diode	Built-in damper diode	No built-in damper diode	**I _C (sat)
2 A	2SD1553 (8V)	2SD1543 (8V)	2SD868 (8V)	2SD818 (8V)	2SD1425 (8V)	2SD1429 (8V)							2 A
2.2 A	2SD2089 (1V)												2.2 A
2.5 A	2SC3715 (5V)			\$2SD811 (10V)									2.5 A
3 A	2SC3716 (5V) 2SD1554 (8V) 2SD2599 (8V)	2SD1544 (8V)	2SD869 (8V)	2SD819 (8V)	2SD1426 (8V)	2SD1430 (8V)		2SD2550 (5V)					3 A
3.5 A	2SD2095 (5V) 2SD2586 (5V)							2SC4765 (5V)	2SC4806 (5V)				3.5 A
4 A	2SC4764 (5V) 2SD1555 (5V) 2SD2499 (5V)	2SC3844A (5V) 2SC4830 (5V) 2SD1545 (5V) 2SD2498 (5V)	2SD870 (5V)	2SD820 (5V)	2SD1427 (5V)	*2SC3887 (5V) 2SC3887A (5V) 2SD1431 (5V)		2SD2551 (5V)					4 A
4.5 A	S2055AF (1V) S2055F (5V) S2055N (5V)	S2000AF (1V) S2000F (5V) S2000N (5V)			S2055 (5V) S2055A (1V)	S2000 (5V) S2000A (1V)		2SC4766 (5V)	2SC4761 (5V)				4.5 A
5 A	2SC4762 (5V) 2SC4916 (5V) 2SC5149 (5V) 2SC5339 (5V) 2SD1556 (5V) 2SD2125 (5V) 2SD2539 (5V)	2SC3885A (5V) 2SC4757 (5V) 2SC5148 (3V) 2SD1546 (5V)	2SD871 (5V)	2SD821 (5V)	*2SC3892 (5V) 2SC3892A (5V) 2SD1429 (5V)	*2SC3888 (5V) 2SC3888A (5V) 2SD1432 (5V)		2SD2253 (5V)					5 A
5.5 A								2SD2638 (5V)					5.5 A
6 A	2SC4763 (5V) 2SC5280 (5V) 2SD2348 (5V) 2SD2559 (5V)	2SC3886A (5V) 2SC4758 (5V) 2SC5129 (3V) 2SC5386 (3V) 2SD1547 (5V) 2SD2500 (3V)		2SD822 (5V)	*2SC3893 (5V) 2SC3893A (5V)	*2SC3889 (5V) 2SC3889A (5V) 2SD1433 (5V)		2SC5143 (3V) 2SC5716 (5V) 2SD2428 (5V) 2SD2454 (5V) 2SD2553 (5V)	2SC5150 (3V)	2SC4608 (5V)		2SC4760 (5V)	6 A
7 A	2SC4531 (5V) 2SC2349 (5V)	2SC4542 (5V) 2SC4759 (5V) 2SC5404 (3V)				2SC4560 (5V)							7 A
8 A		2SD1548 (5V) 2SC5048 (3V) 2SC5387 (3V)		*2SD1279 (5V)					2SC4532 (5V)	2SC5332 (3V)			8 A
9 A													9 A
10 A							2SC5331 *2SC4288 (5V)						10 A
11 A		2SC5411 (3V) *(S3D20)					2SC4288A (5V) 2SC5421 (3V)			2SC5422 (3V)			11 A
12 A									2SC5588 (3V)	2SC5590 (3V)	*(2SC5749)	*(2SC5748)	12 A
14 A		2SC5587 (3V)					*2SC4289 (5V) 2SC4289A (5V) *2SC4290 (5V) 2SC4290A (5V) 2SC5142 (3V) 2SC5589 (3V) 2SC5445 (3V)			2SC5446 (3V)			14 A
15 A													15 A
17 A		2SC5717 (3V)						2SC5695 (3V)				2SC5612 (3V)	17 A
22 A										2SC5570 (3V) *(S3D21)			22 A

Notes: **I_C(sat) is value of I_C for V_{CE}(sat).
 (5V) means V_{CE}(sat) = 5 V
 [Grey box]: Superseded, final-phase or discontinued products
 [Red box]: 3rd generation (old design)
 [Blue box]: 4th generation (new design)
 [Red box with asterisk]: 5th generation (new design)
 [Red box with asterisk and 'under development'] : 5th generation (new design under development)

**Toshiba America
Electronic Components, Inc.**

Headquarters-Irvine, CA
9775 Toledo Way, Irvine, CA 92618, U.S.A.
Tel: (949)455-2000 Fax: (949)859-3963

Boulder, CO
3100 Arapahoe Avenue, Ste. 500,
Boulder, CO 80303, U.S.A.
Tel: (303)442-3801 Fax: (303)442-7216

Boynton Beach, FL(Orlando)
11924 W. Forest Hill Blvd., Ste. 22-337,
Boynton Beach, FL 33414, U.S.A.
Tel: (561)374-6193 Fax: (561)374-6194

Deerfield, IL(Chicago)
One Pkwy., North, Suite 500, Deerfield,
IL 60015-2547, U.S.A.
Tel: (847)945-1500 Fax: (847)945-1044

Duluth, GA(Atlanta)
3700 Crestwood Parkway, Ste. 460,
Duluth, GA 30096, U.S.A.
Tel: (770)931-3363 Fax: (770)931-7602

Edison, NJ
2035 Lincoln Hwy. Ste. #3000, Edison
NJ 08817, U.S.A.
Tel: (732)248-8070 Fax: (732)248-8030

Orange County, CA
2 Venture Plaza, #500 Irvine, CA 92618, U.S.A.
Tel: (949)453-0224 Fax: (949)453-0125

Portland, OR
1700 NW 167th Place, #240,
Beaverton, OR 97006, U.S.A.
Tel: (503)629-0818 Fax: (503)629-0827

Raleigh, NC
5511 Capitol Center Dr., #114,
Raleigh, NC 27606, U.S.A.
Tel: (919)859-2800 Fax: (919)859-2898

Richardson, TX(Dallas)
777 East Campbell Rd., Suite 650, Richardson,
TX 75081, U.S.A.
Tel: (972)480-0470 Fax: (972)235-4114

San Jose Engineering Center, CA
1060 Rincon Circle, San Jose, CA 95131, U.S.A.
Tel: (408)526-2400 Fax: (408)526-2410

Wakefield, MA(Boston)
401 Edgewater Place, Suite #360, Wakefield,
MA 01880-6229, U.S.A.
Tel: (781)224-0074 Fax: (781)224-1095

Toshiba Do Brasil S.A.

Electronic Components Div.
Estrada Dos Alvarengas, 5. 500-Bairro Alvarenga
09850-550-Sao Bernardo do campo - SP
Tel: (011)7689-7171 Fax: (011)7689-7189

Toshiba Electronics Europe GmbH

Düsseldorf Head Office
Hansaallee 181, D-40549 Düsseldorf
Germany
Tel: (0211)5296-0 Fax: (0211)5296-400

München Office
Büro München Hofmannstrasse 52,
D-81378, München, Germany
Tel: (089)748595-0 Fax: (089)748595-42

Toshiba Electronics France SARL
Immeuble Robert Schumann 3 Rue de Rome,
F-93561, Rosny-Sous-Bois, Cedex, France
Tel: (1)48-12-48-12 Fax: (1)48-94-51-15

Toshiba Electronics Italiana S.R.L.
Centro Direzionale Colleoni
Palazzo Perseo Ingr. 2-Piano 6,
Via Paracelso n.12,
1-20041 Agrate Brianza Milan, Italy
Tel: (039)68701 Fax:(039)6870205

Toshiba Electronics España, S.A.
Parque Empresarial San Fernando Edificio Europa,
1ª Planta, ES-28831 Madrid, Spain
Tel: (91)660-6700 Fax:(91)660-6799

Toshiba Electronics(UK) Limited
Riverside Way, Camberley Surrey,
GU15 3YA, U.K.
Tel: (01276)69-4600 Fax: (01276)69-4800

Toshiba Electronics Scandinavia AB
Gustavslundsvägen 12, 2nd Floor
S-161 15 Bromma, Sweden
Tel: (08)704-0900 Fax: (08)80-8459

**Toshiba Electronics Asia
(Singapore) Pte. Ltd.**

Singapore Head Office
438B Alexandra Road, #06-08/12 Alexandra
Technopark, Singapore 119968
Tel: (278)5252 Fax: (271)5155

Bangkok Office
135 Moo 5 Bangkadi Industrial Park, Tivanon Rd.,
Bangkadi Amphur Muang Pathumthani, Bangkok, 12000,
Thailand
Tel: (02)501-1635 Fax: (02)501-1638

**Toshiba Electronics Trading
(Malaysia)Sdn. Bhd.**

Kuala Lumpur Head Office
Suite W1203, Wisma Consplant, No.2,
Jalan SS 16/4, Subang Jaya, 47500 Petaling Jaya,
Selangor Darul Ehsan, Malaysia
Tel: (3)731-6311 Fax: (3)731-6307

Penang Office
Suite 13-1, 13th Floor, Menard Penang Garden,
42-A, Jalan Sultan Ahmad Shah,
10050 Penang, Malaysia
Tel: 4-226-8523 Fax: 4-226-8515

Toshiba Electronics Philippines, Inc.

26th Floor, Citibank Tower, Valero Street, Makati,
Manila, Philippines
Tel: (02)750-5510 Fax: (02)750-5511

Toshiba Electronics Asia, Ltd.

Hong Kong Head Office
Level 11, Top Glory Insurance Building, Grand Century
Place, No.193, Prince Edward Road West,
Mong Kok, Kowloon, Hong Kong
Tel: 2375-6111 Fax: 2375-0969

Beijing Office
Rm 714, Beijing Fortune Building,
No.5 Dong San Huan Bei-Lu, Chao Yang District,
Beijing, 100004, China
Tel: (010)6590-8795 Fax: (010)6590-8791

Chengdu Office
Unit F, 18th Floor, New Times Plaza, 42 Wenwu Road,
Xinhua Avenue, Chengdu, 610017, China
Tel: (028)675-1773 Fax: (028)675-1065

Shenzhen Office
Rm 3010-3012, Office Tower Shun Hing Square,
Di Wang Commercial Centre, 333 ShenNan
East Road, Shenzhen, 518008, China
Tel: (0755)246-1582 Fax: (0755)246-1581

Toshiba Electronics Korea Corporation

Seoul Head Office
14/F, KEC B/D, 257-7 Yangjae-Dong,
Seocho-ku, Seoul, Korea
Tel: (02)589-4334 Fax: (02)589-4302

Gumi Office
6/F, Ssangyong Investment Securities B/D,
56 Songjung-Dong, Gumi City
Kyeongbuk, Korea
Tel: (82)54-456-7613 Fax: (82)54-456-7617

**Toshiba Technology Development
(Shanghai) Co., Ltd.**

23F, Shanghai Senmao International Building, 101
Yin Cheng East Road, Pudong New Area, Shanghai,
200120, China
Tel: (021)6841-0666 Fax: (021)6841-5002

**Tsurong Xiamen Xiangyu Trading
Co., Ltd.**

8N, Xiamen SEZ Bonded Goods Market Building,
Xiamen, Fujian, 361006, China
Tel: (0592)562-3798 Fax: (0592)562-3799

**Toshiba Electronics Taiwan
Corporation**

Taipei Head Office
17F, Union Enterprise Plaza Bldg. 109
Min Sheng East Rd., Section 3, 0446 Taipei,
Taiwan
Tel: (02)514-9988 Fax: (02)514-7892

Kaohsiung Office
16F-A, Chung-Cheng Bldg., Chung-Cheng 3Rd.,
80027, Kaohsiung, Taiwan
Tel: (07)222-0826 Fax: (07)223-0046

The information contained herein is subject to change without notice.

The information contained herein is presented only as a guide for the applications of our products. No responsibility is assumed by TOSHIBA for any infringements of patents or other rights of the third parties which may result from its use. No license is granted by implication or otherwise under any patent or patent rights of TOSHIBA or others.

TOSHIBA is continually working to improve the quality and reliability of its products. Nevertheless, semiconductor devices in general can malfunction or fail due to their inherent electrical sensitivity and vulnerability to physical stress. It is the responsibility of the buyer, when utilizing TOSHIBA products, to comply with the standards of safety in making a safe design for the entire system, and to avoid situations in which a malfunction or failure of such TOSHIBA products could cause loss of human life, bodily injury or damage to property. In developing your designs, please ensure that TOSHIBA products are used within specified operating ranges as set forth in the most recent TOSHIBA products specifications. Also, please keep in mind the precautions and conditions set forth in the "Handling Guide for Semiconductor Devices," or "TOSHIBA Semiconductor Reliability Handbook" etc..

The Toshiba products listed in this document are intended for usage in general electronics applications (computer, personal equipment, office equipment, measuring equipment, industrial robotics, domestic appliances, etc.). These Toshiba products are neither intended nor warranted for usage in equipment that requires extraordinarily high quality and/or reliability or a malfunction or failure of which may cause loss of human life or bodily injury ("Unintended Usage"). Unintended Usage include atomic energy control instruments, airplane or spaceship instruments, transportation instruments, traffic signal instruments, combustion control instruments, medical instruments, all types of safety devices, etc.. Unintended Usage of Toshiba products listed in this document shall be made at the customer's own risk.

In Touch with Tomorrow
TOSHIBA

TOSHIBA CORPORATION

Electronic Devices Sales & Marketing Division
1-1, Shibaura 1-chome, Minato-ku, Tokyo, 105-8001, Japan
Tel: +81-3-3457-3405 Fax: +81-3-5444-9431