

### Features

- Low power loss, high efficiency.
- High current capability, low forward voltage drop.
- High surge capability.
- Guardring for overvoltage protection.
- Ultra high-speed switching.
- Silicon epitaxial planar chip, metal silicon junction.
- Suffix "H" indicates Halogen-free part, ex.MBR2040BCTH. Lead-free parts meet environmental standards of MIL-STD-19500 /228

### Mechanical data

- Epoxy : UL94-V0 rated flame retardant.
- Case : Molded plastic, TO-263 / D<sup>2</sup>PAK
- Terminals : Solder plated, solderable per MIL-STD-750, Method 2026
- Polarity: Indicated by cathode band.
- Mounting Position : Any.
- Weight : Approximated 1.70 gram.

### Maximum ratings and electrical characteristics

Rating at 25°C ambient temperature unless otherwise specified. Single phase, half wave, 60Hz, resistive or inductive load. For capacitive load, derate current by 20%.

### Outline

D<sup>2</sup>PAK(TO-263)

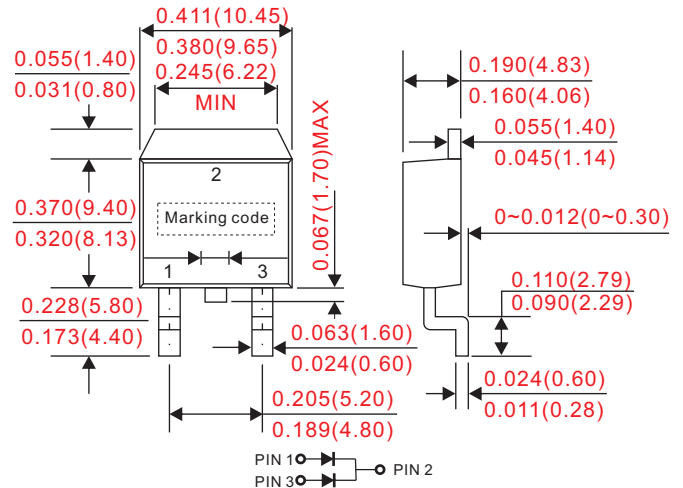

Dimensions in inches and (millimeters)

Parameter	Conditions	Symbol	MIN.	TYP.	MAX.	UNIT
Forward rectified current	See Fig.1	$I_o$			20	A
Forward surge current	8.3ms single half sine-wave superimposed on rate load (JEDEC method)	$I_{FSM}$			150	A
Reverse current	$V_R = V_{RRM}$ $T_A = 25^\circ\text{C}$	$I_R$			0.1	mA
	$V_R = V_{RRM}$ $T_A = 125^\circ\text{C}$				10	
Diode junction capacitance	f=1MHz and applied 4V DC reverse voltage	$C_j$		150		pF
Thermal resistance	Junction to ambient	$R_{\theta JA}$		30		°C/W
Storage temperature		$T_{STG}$	-55		+175	°C

Symbol	Marking code	Max. repetitive peak reverse voltage $V_{RRM}$ (V)	Max. RMS voltage $V_{RMS}$ (V)	Max. DC blocking voltage $V_R$ (V)	Max. forward voltage @10A, $T_A = 25^\circ\text{C}$ $V_F$ (V)	Max. forward voltage @10A, $T_A = 125^\circ\text{C}$ $V_F$ (V)	Operating temperature $T_J$ (°C)
MBR2040BCT	MBR2040CT	40	28	40	0.70	0.57	-55 ~ +150
MBR2045BCT	MBR2045CT	45	31.5	45			
MBR2060BCT	MBR2060CT	60	42	60	0.79	0.70	
MBR2065BCT	MBR2065CT	65	45.5	65			
MBR20100BCT	MBR20100CT	100	70	100	0.81	0.71	-55 ~ +175
MBR20150BCT	MBR20150CT	150	105	150	0.87	0.77	
MBR20200BCT	MBR20200CT	200	140	200	0.90	0.80	

■ Rating and characteristic curves

Fig.1 - Forward Current Derating Curve

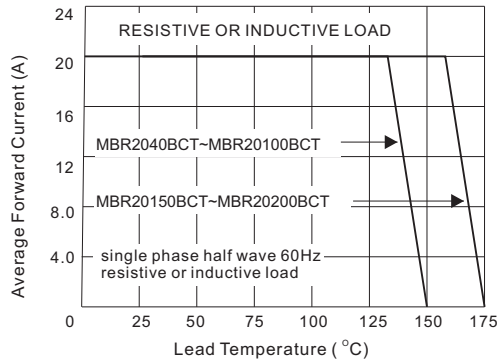

Fig. 2 - Maximum Non-Repetitive Peak Forward Surge Current

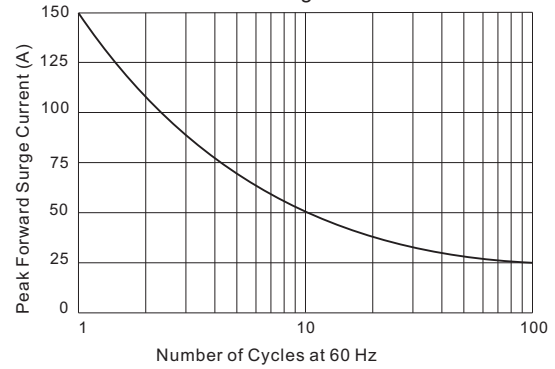

Fig. 3.1 - Typical Instantaneous Forward Characteristics

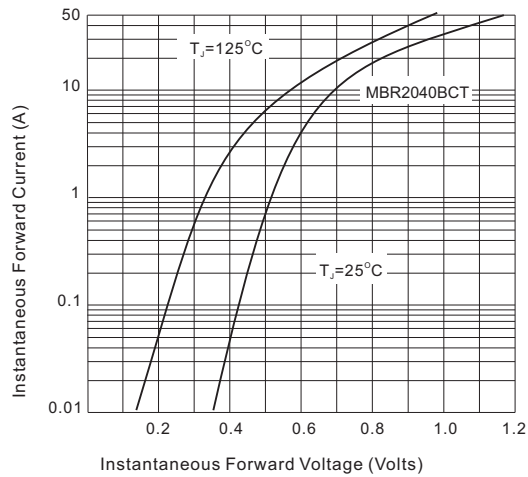

Fig. 3.2 - Typical Instantaneous Forward Characteristics

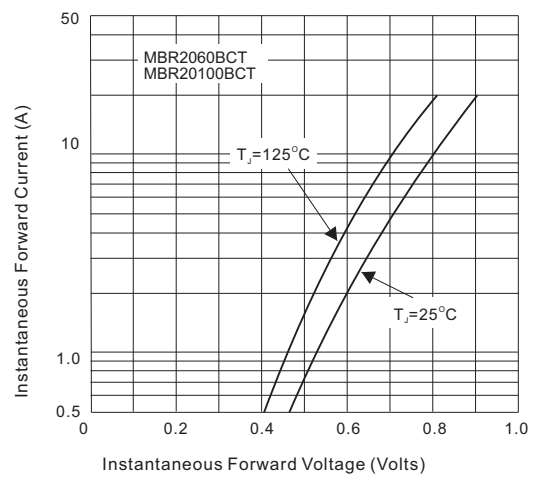

Fig. 3.3 - Typical Instantaneous Forward Characteristics

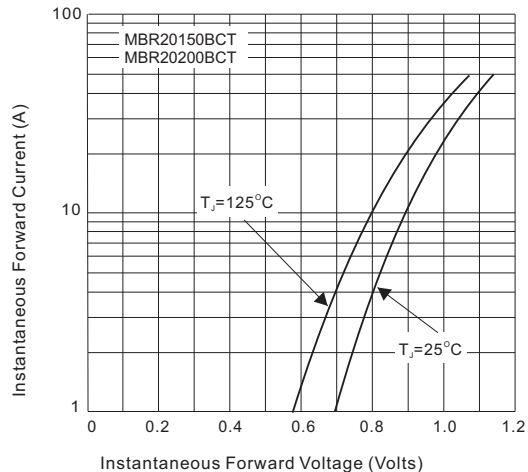
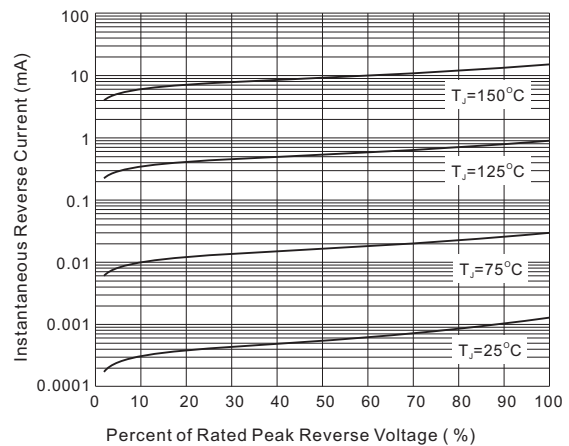
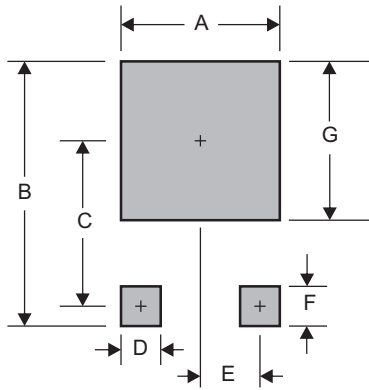

Fig. 4 - Typical Reverse Characteristics



■ D<sup>2</sup>PAK(TO-263) foot print



A	B	C	D	E	F	G
0.425 (10.80)	0.665 (16.90)	0.374 (9.50)	0.071 (1.80)	0.098 (2.50)	0.138 (3.50)	0.449 (11.40)

Dimensions in inches and (millimeters)