

PIN Connection TO-220F

Switching Regulator Application

Features

- Drain-Source breakdown voltage: $BV_{DSS}=900V$ (Min.)
- Low gate charge: $Q_g=58nC$ (Typ.)
- Low drain-source On resistance: $R_{DS(on)}=1.4\Omega$ (Max.)
- 100% avalanche tested
- RoHS compliant device

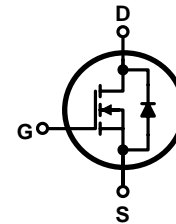
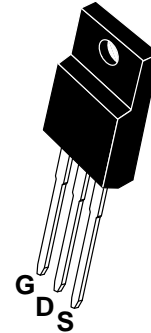

Marking Diagram



- Y = Year
- A = Assembly Location
- WW = Work Week
- FIR9N90F = Specific Device Code

Absolute maximum ratings ($T_c=25^\circ C$ unless otherwise noted)

Characteristic	Symbol	Rating	Unit	
Drain-source voltage	V_{DSS}	900	V	
Gate-source voltage	V_{GSS}	± 30	V	
Drain current (DC) *	I_D	$T_c=25^\circ C$	9.5	A
		$T_c=100^\circ C$	6	A
Drain current (Pulsed) *	I_{DM}	38	A	
Single pulsed avalanche energy ^(Note 2)	E_{AS}	860	mJ	
Repetitive avalanche current ^(Note 1)	I_{AR}	9.5	A	
Repetitive avalanche energy ^(Note 1)	E_{AR}	19.8	mJ	
Power dissipation	P_D	198	W	
Peak diode recovery dv/dt ^(Note 3)	dv/dt	4.5	V/ns	
Junction temperature	T_J	150	$^\circ C$	
Storage temperature range	T_{stg}	-55-150	$^\circ C$	

* Limited only maximum junction temperature

Thermal Characteristics

Characteristic	Symbol	Rating	Unit
Thermal resistance, junction to case	$R_{th(j-c)}$	Max. 0.63	°C/W
Thermal resistance, junction to ambient	$R_{th(j-a)}$	Max. 62.5	

Electrical Characteristics ($T_c=25^\circ\text{C}$ unless otherwise noted)

Characteristic	Symbol	Test Condition	Min.	Typ.	Max.	Unit
Drain-source breakdown voltage	BV_{DSS}	$I_D=250\mu\text{A}$, $V_{GS}=0$	900	-	-	V
Gate threshold voltage	$V_{GS(th)}$	$I_D=250\mu\text{A}$, $V_{DS}=V_{GS}$	2	-	4	V
Drain-source cut-off current	I_{DSS}	$V_{DS}=900\text{V}$, $V_{GS}=0\text{V}$	-	-	10	μA
		$V_{DS}=720\text{V}$, $T_c=125^\circ\text{C}$	-	-	100	μA
Gate leakage current	I_{GSS}	$V_{DS}=0\text{V}$, $V_{GS}=\pm 30\text{V}$	-	-	± 100	nA
Drain-source on-resistance	$R_{DS(ON)}$	$V_{GS}=10\text{V}$, $I_D=4.75\text{A}$	-	1.13	1.4	Ω
Forward transfer conductance (Note 4)	g_{fs}	$V_{DS}=10\text{V}$, $I_D=4.75\text{A}$	-	10	-	S
Input capacitance	C_{iss}	$V_{DS}=25\text{V}$, $V_{GS}=0\text{V}$, $f=1.0\text{MHz}$	-	2548	3440	pF
Output capacitance	C_{oss}		-	197	266	
Reverse transfer capacitance	C_{rss}		-	32	51	
Turn-on delay time (Note 4,5)	$t_{d(on)}$	$V_{DD}=450\text{V}$, $I_D=9.5\text{A}$, $R_G=25\Omega$	-	61	-	ns
Rise time (Note 4,5)	t_r		-	49	-	
Turn-off delay time (Note 4,5)	$t_{d(off)}$		-	318	-	
Fall time (Note 4,5)	t_f		-	100	-	
Total gate charge (Note 4,5)	Q_g	$V_{DS}=720\text{V}$, $V_{GS}=10\text{V}$, $I_D=9.5\text{A}$	-	58	78	nC
Gate-source charge (Note 4,5)	Q_{gs}		-	11	-	
Gate-drain charge (Note 4,5)	Q_{gd}		-	22	-	

Source-Drain Diode Ratings and Characteristics ($T_c=25^\circ\text{C}$ unless otherwise noted)

Characteristic	Symbol	Test Condition	Min.	Typ.	Max.	Unit
Source current (DC)	I_S	Integral reverse diode in the MOSFET	-	-	9.5	A
Source current (Pulsed)	I_{SM}		-	-	38	A
Forward voltage	V_{SD}	$V_{GS}=0\text{V}$, $I_S=9.5\text{A}$	-	-	1.5	V
Reverse recovery time (Note 4,5)	t_{rr}	$I_S=9.5\text{A}$, $V_{GS}=0\text{V}$ $di_f/dt=100\text{A}/\mu\text{s}$	-	550	-	ns
Reverse recovery charge (Note 4,5)	Q_{rr}		-	6.5	-	μC

Note:

1. Repeated rating: Pulse width limited by safe operating area
2. $L=18\text{mH}$, $I_{AS}=9.5\text{A}$, $V_{DD}=50\text{V}$, $R_G=25\Omega$, Starting $T_J=25^\circ\text{C}$
3. $I_{SD}\leq 9\text{A}$, $di/dt\leq 200\text{A}/\mu\text{s}$, $V_{DD}\leq BV_{DSS}$, Starting $T_J=25^\circ\text{C}$
4. Pulse test: Pulse width $\leq 300\mu\text{s}$, Duty cycle $\leq 2\%$
5. Essentially independent of operating temperature typical characteristics

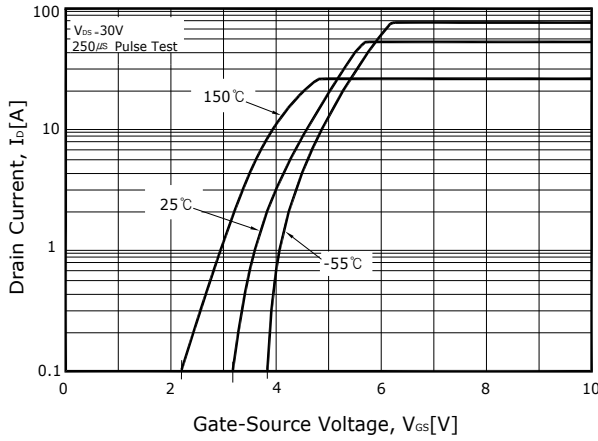
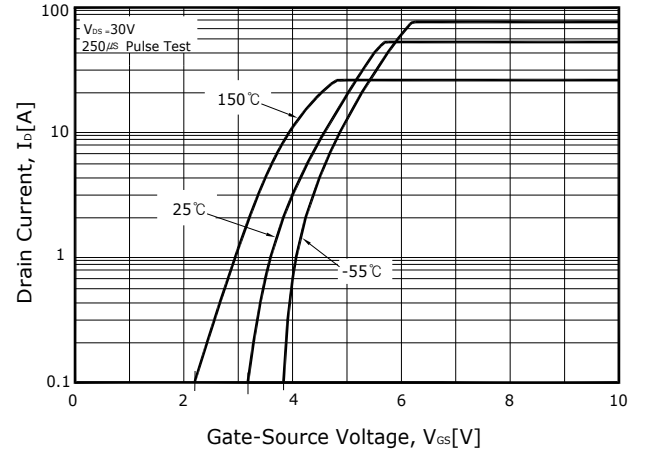
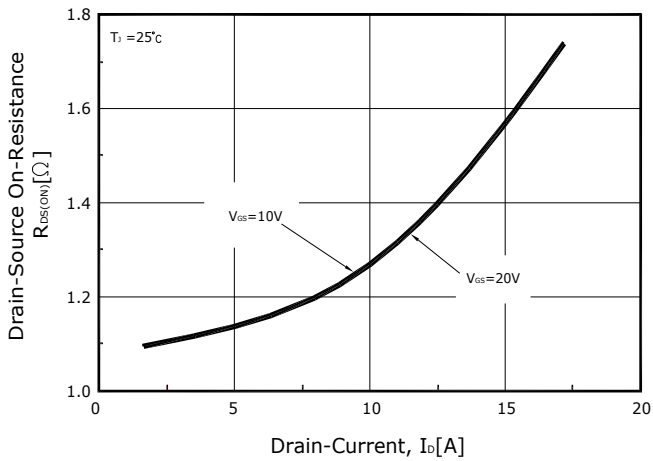
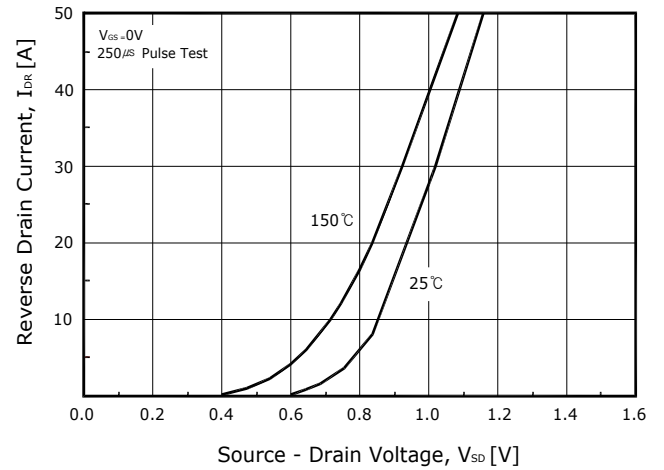
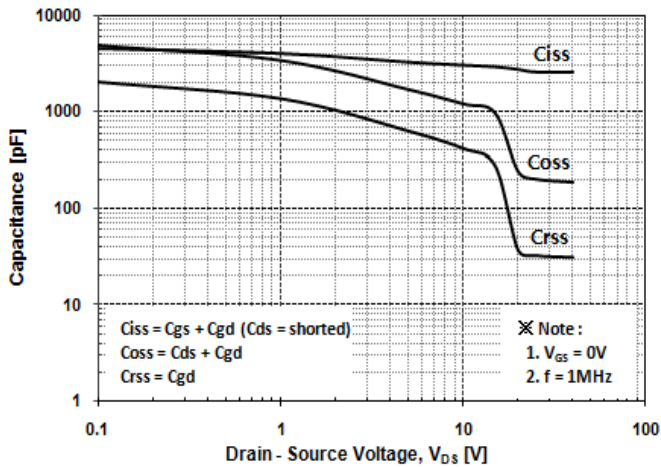
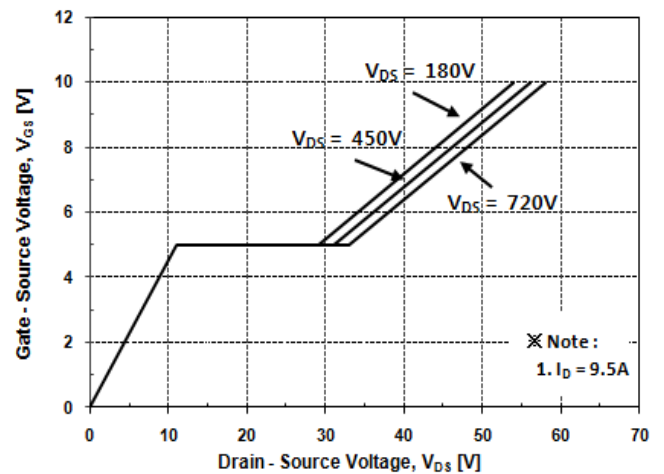
Electrical Characteristics Curve
Fig. 1 $I_D - V_{DS}$

Fig. 2 $I_D - V_{GS}$

Fig. 3 $R_{DS(ON)} - I_D$

Fig. 4 $I_{DR} - V_{SD}$

Fig. 5 Capacitance - V_{DS}

Fig. 6 $V_{GS} - Q_G$

Electrical Characteristics Curve (Continue)
Fig. 7 $BV_{DSS} - T_J$

Fig. 8 $R_{DS(ON)} - T_J$

Fig. 9 $I_D - T_C$

Fig. 10 Safe Operating Area

Fig. 11 Transient Thermal Impedance

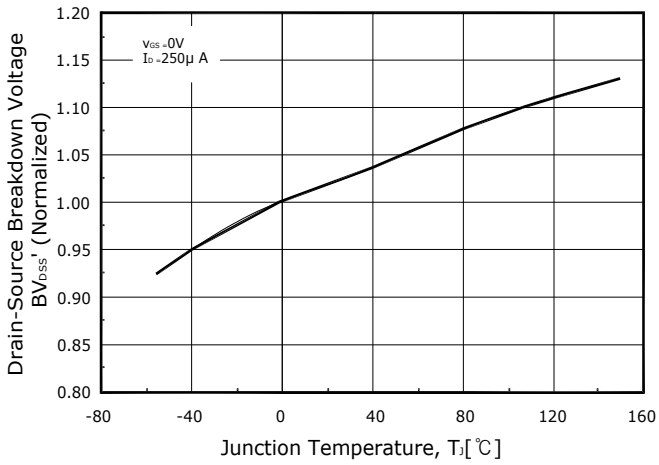
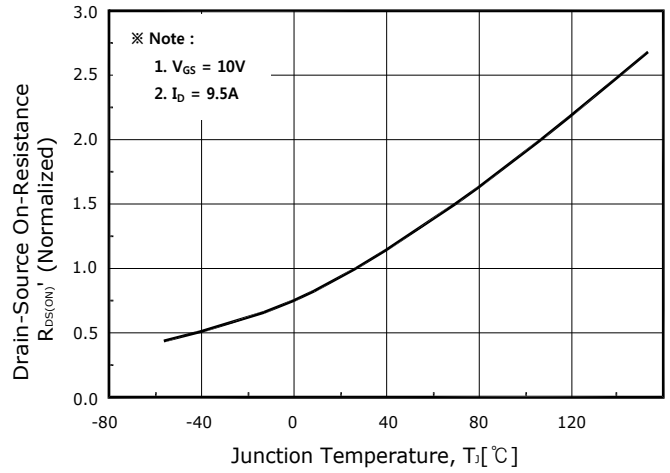
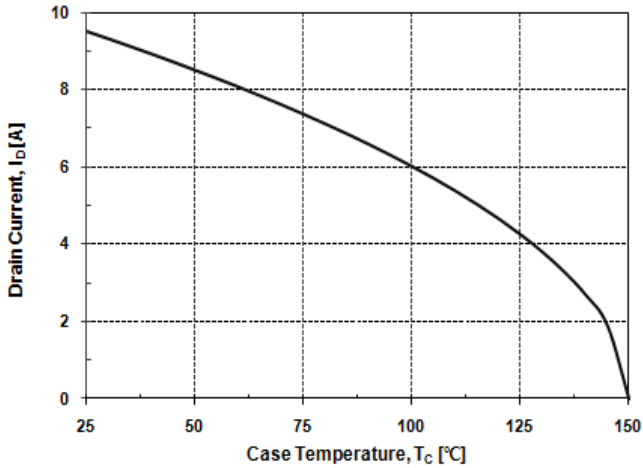
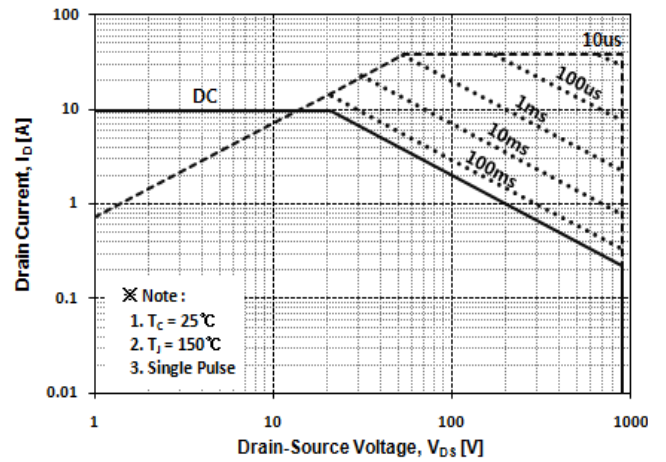
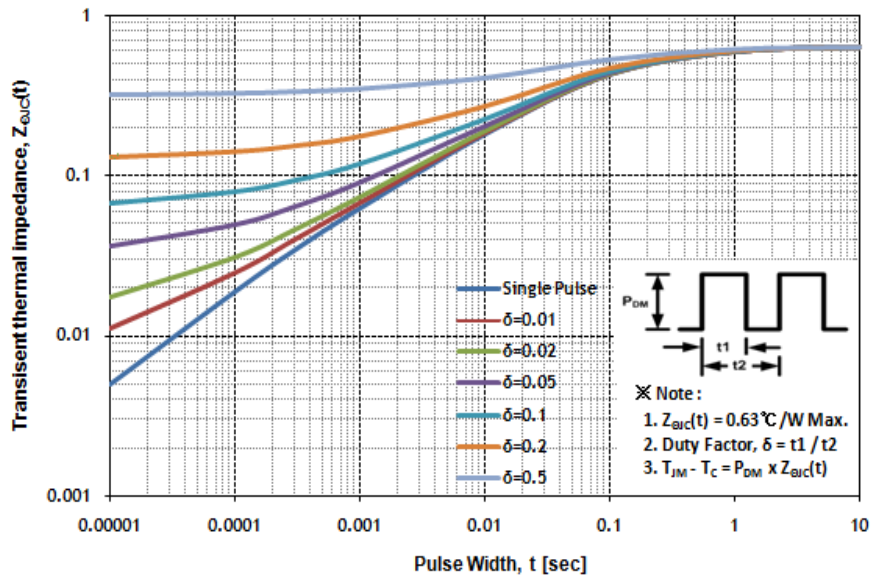
Fig. 12 Gate Charge Test Circuit & Waveform

Fig. 13 Resistive Switching Test Circuit & Waveform

Fig. 14 E_{AS} Test Circuit & Waveform

Fig. 15 Diode Reverse Recovery Time Test Circuit & Waveform

Package Dimensions

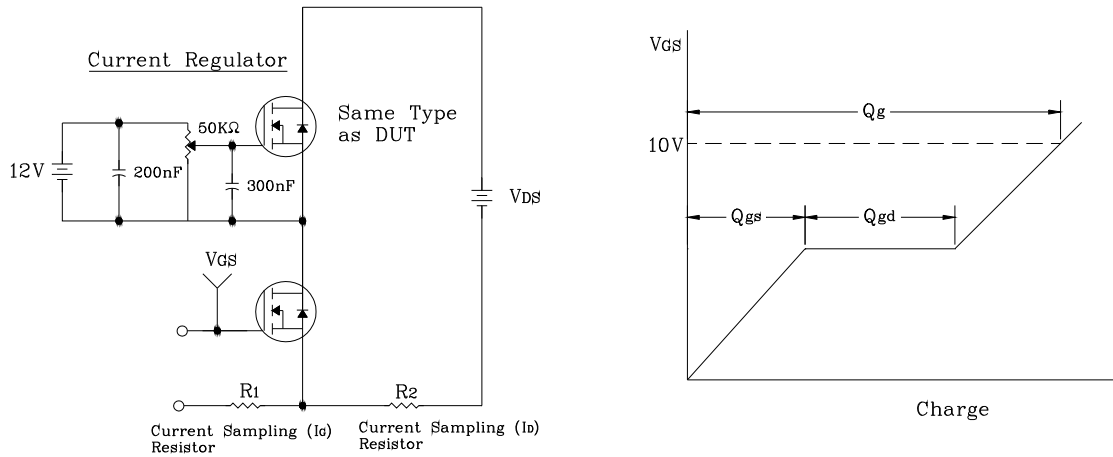
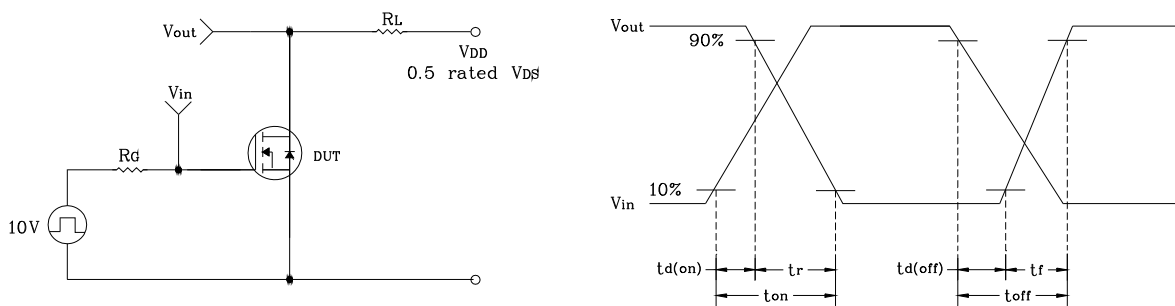
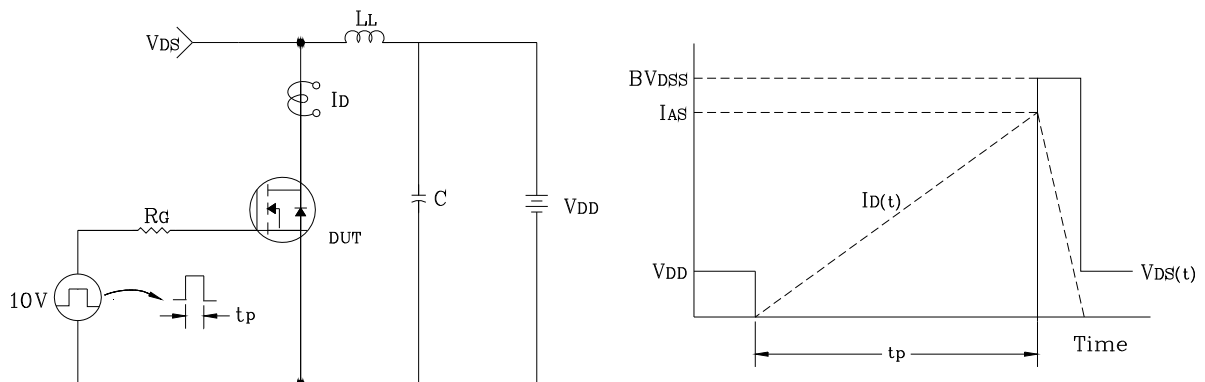
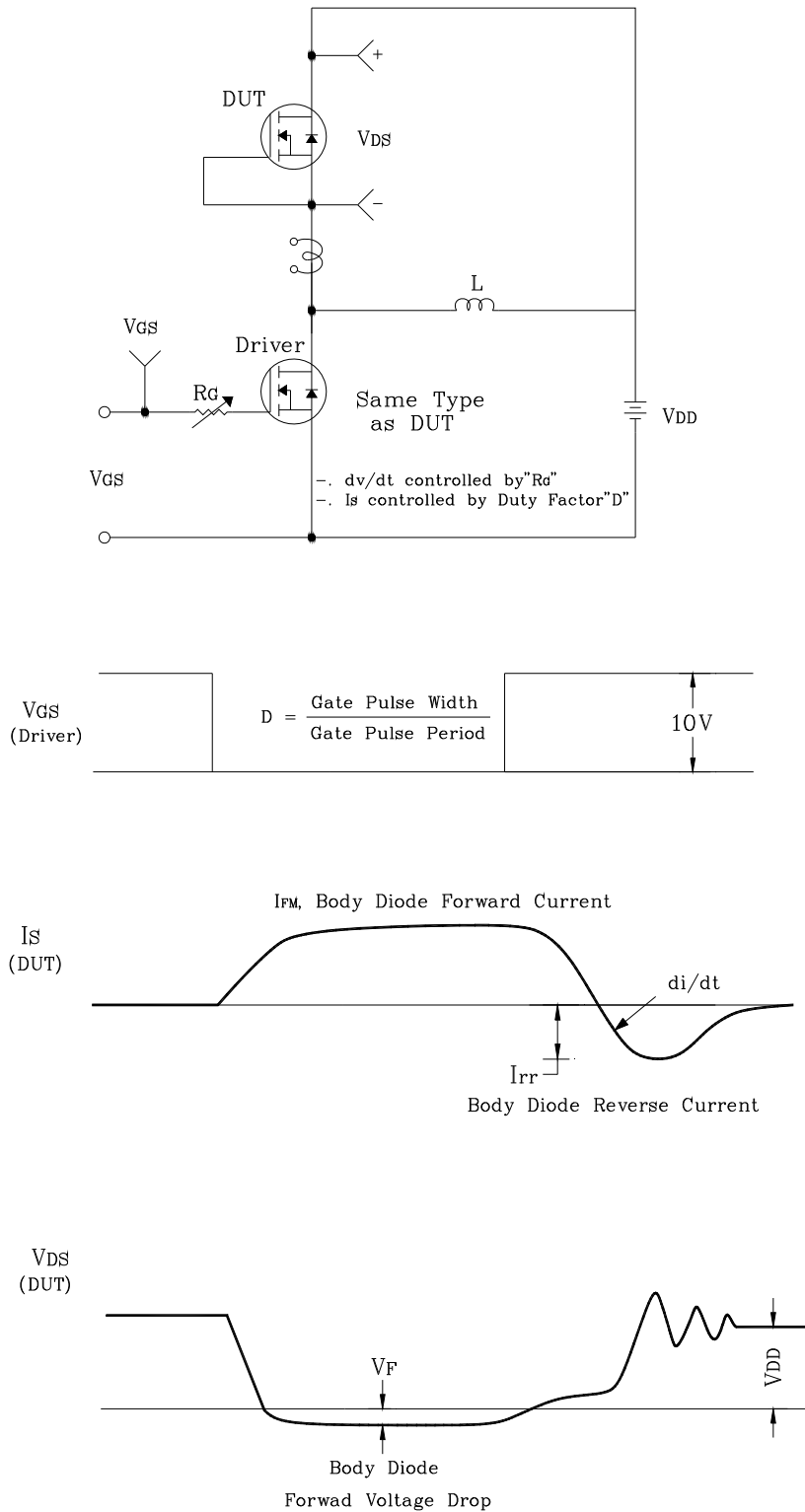
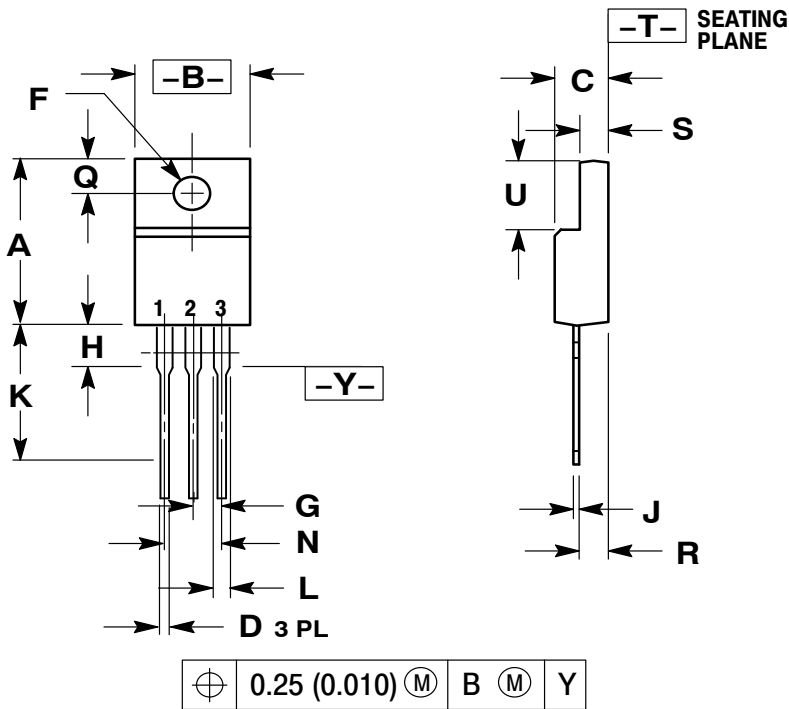
TO-220F



NOTES:

1. DIMENSIONING AND TOLERANCING PER ANSI Y14.5M, 1982.
2. CONTROLLING DIMENSION: INCH
3. 221D-01 THRU 221D-02 OBSOLETE, NEW STANDARD 221D-03.

DIM	INCHES		MILLIMETERS	
	MIN	MAX	MIN	MAX
A	0.617	0.635	15.67	16.12
B	0.392	0.419	9.96	10.63
C	0.177	0.193	4.50	4.90
D	0.024	0.039	0.60	1.00
F	0.116	0.129	2.95	3.28
G	0.100 BSC		2.54 BSC	
H	0.118	0.135	3.00	3.43
J	0.018	0.025	0.45	0.63
K	0.503	0.541	12.78	13.73
L	0.048	0.058	1.23	1.47
N	0.200 BSC		5.08 BSC	
Q	0.122	0.138	3.10	3.50
R	0.099	0.117	2.51	2.96
S	0.092	0.113	2.34	2.87
U	0.239	0.271	6.06	6.88