

Features

- Improved E_{off} at elevated temperature
- Minimal tail current
- Low conduction losses
- $V_{CE(sat)}$ classified for easy parallel connection
- Ultra fast soft recovery antiparallel diode

Applications

- Welding
- High frequency converters
- Power factor correction

Description

The STGW35HF60WD is based on a new advanced planar technology concept to yield an IGBT with more stable switching performance (E_{off}) versus temperature, as well as lower conduction losses. The device is tailored to high switching frequency operation (over 100 kHz).

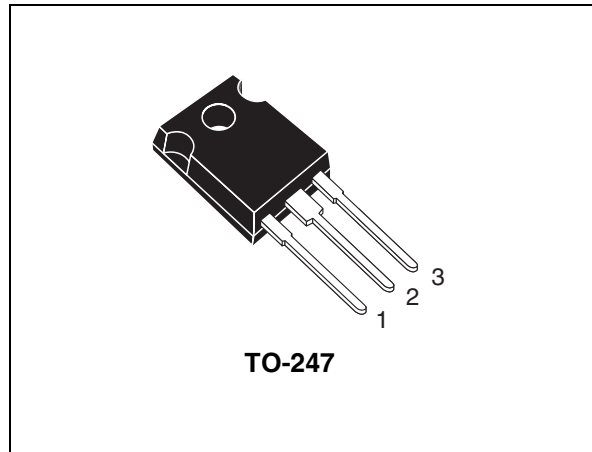

Figure 1. Internal schematic diagram

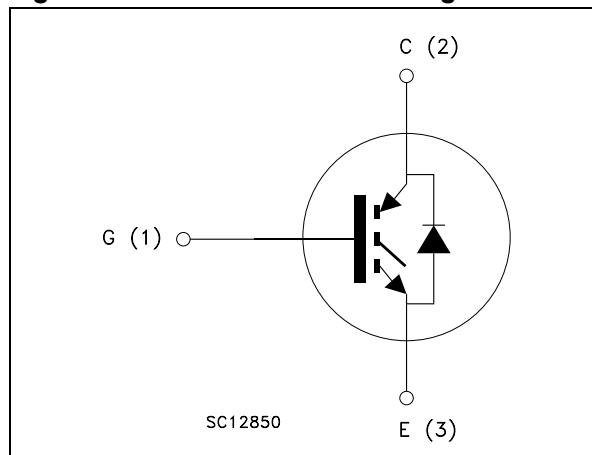

Table 1. Device summary

Order code	Marking ⁽¹⁾	Package	Packaging
STGW35HF60WD	GW35HF60WDA	TO-247	Tube
	GW35HF60WDB		
	GW35HF60WDC		

1. Collector-emitter saturation voltage is classified in group A, B and C, see [Table 5: VCE\(sat\) classification](#). STMicroelectronics reserves the right to ship from any group according to production availability.

1 Electrical ratings

Table 2. Absolute maximum ratings

Symbol	Parameter	Value	Unit
V_{CES}	Collector-emitter voltage ($V_{GE} = 0$)	600	V
$I_C^{(1)}$	Continuous collector current at $T_C = 25\text{ °C}$	60	A
$I_C^{(1)}$	Continuous collector current at $T_C = 100\text{ °C}$	35	A
$I_{CP}^{(2)}$	Pulsed collector current	150	A
$I_{CL}^{(3)}$	Turn-off latching current	80	A
V_{GE}	Gate-emitter voltage	± 20	V
I_F	Diode RMS forward current at $T_C = 25\text{ °C}$	30	A
I_{FSM}	Surge non repetitive forward current $t_p = 10\text{ ms}$ sinusoidal	120	A
P_{TOT}	Total dissipation at $T_C = 25\text{ °C}$	200	W
T_{stg}	Storage temperature	- 55 to 150	°C
T_j	Operating junction temperature		

1. Calculated according to the iterative formula:

$$I_C(T_C) = \frac{T_{j(max)} - T_C}{R_{thj-c} \times V_{CE(sat)(max)}(T_{j(max)}, I_C(T_C))}$$

- Pulse width limited by maximum junction temperature and turn-off within RBSOA
- $V_{CLAMP} = 80\% (V_{CES})$, $V_{GE} = 15\text{ V}$, $R_G = 10\text{ }\Omega$, $T_J = 150\text{ °C}$

Table 3. Thermal data

Symbol	Parameter	Value	Unit
$R_{thj-case}$	Thermal resistance junction-case IGBT	0.63	°C/W
	Thermal resistance junction-case diode	1.5	°C/W
$R_{thj-amb}$	Thermal resistance junction-ambient	50	°C/W

2 Electrical characteristics

($T_J = 25\text{ °C}$ unless otherwise specified)

Table 4. Static

Symbol	Parameter	Test conditions	Min.	Typ.	Max.	Unit
$V_{(BR)CES}$	Collector-emitter breakdown voltage ($V_{GE} = 0$)	$I_C = 1\text{ mA}$	600			V
$V_{CE(sat)}$	Collector-emitter saturation voltage	$V_{GE} = 15\text{ V}, I_C = 20\text{ A}$			2.5	V
		$V_{GE} = 15\text{ V}, I_C = 20\text{ A}, T_J = 125\text{ °C}$		1.65		
$V_{GE(th)}$	Gate threshold voltage	$V_{CE} = V_{GE}, I_C = 1\text{ mA}$	3.75		5.75	V
I_{CES}	Collector cut-off current ($V_{GE} = 0$)	$V_{CE} = 600\text{ V}$			250	μA
		$V_{CE} = 600\text{ V}, T_J = 125\text{ °C}$			1	mA
I_{GES}	Gate-emitter leakage current ($V_{CE} = 0$)	$V_{GE} = \pm 20\text{ V}$			± 100	nA

Table 5. $V_{CE(sat)}$ classification

Symbol	Parameter	Group	Value		Unit
			Min.	Max.	
$V_{CE(sat)}$	Collector-emitter saturation voltage $V_{GE} = 15\text{ V}, I_C = 20\text{ A}$	A	1.68	1.92	V
		B	1.88	2.17	
		C	2.13	2.50	

Table 6. Dynamic

Symbol	Parameter	Test conditions	Min.	Typ.	Max.	Unit
C_{ies}	Input capacitance	$V_{CE} = 25\text{ V}, f = 1\text{ MHz},$ $V_{GE} = 0$	-	2400	-	μF
C_{oes}	Output capacitance			235		μF
C_{res}	Reverse transfer capacitance			50		μF
Q_g	Total gate charge	$V_{CE} = 400\text{ V}, I_C = 20\text{ A},$	-	140	-	nC
Q_{ge}	Gate-emitter charge	$V_{GE} = 15\text{ V},$		13		nC
Q_{gc}	Gate-collector charge	(see Figure 17)		52		nC

Table 7. Switching on/off (inductive load)

Symbol	Parameter	Test conditions	Min.	Typ.	Max.	Unit
$t_{d(on)}$ t_r $(di/dt)_{on}$	Turn-on delay time Current rise time Turn-on current slope	$V_{CC} = 400\text{ V}$, $I_C = 20\text{ A}$ $R_G = 10\ \Omega$, $V_{GE} = 15\text{ V}$, (see Figure 16)	-	30 15 1650	-	ns ns A/ μ s
$t_{d(on)}$ t_r $(di/dt)_{on}$	Turn-on delay time Current rise time Turn-on current slope	$V_{CC} = 400\text{ V}$, $I_C = 20\text{ A}$ $R_G = 10\ \Omega$, $V_{GE} = 15\text{ V}$, $T_J = 125\text{ }^\circ\text{C}$ (see Figure 16)	-	30 15 1600	-	ns ns A/ μ s
$t_r(V_{off})$ $t_{d(off)}$ t_f	Off voltage rise time Turn-off delay time Current fall time	$V_{CC} = 400\text{ V}$, $I_C = 20\text{ A}$, $R_{GE} = 10\ \Omega$, $V_{GE} = 15\text{ V}$ (see Figure 16)	-	30 175 40	-	ns ns ns
$t_r(V_{off})$ $t_{d(off)}$ t_f	Off voltage rise time Turn-off delay time Current fall time	$V_{CC} = 400\text{ V}$, $I_C = 20\text{ A}$, $R_{GE} = 10\ \Omega$, $V_{GE} = 15\text{ V}$, $T_J = 125\text{ }^\circ\text{C}$ (see Figure 16)	-	50 225 70	-	ns ns ns

Table 8. Switching energy (inductive load)

Symbol	Parameter	Test conditions	Min.	Typ.	Max.	Unit
$E_{on}^{(1)}$ E_{off} E_{ts}	Turn-on switching losses Turn-off switching losses Total switching losses	$V_{CC} = 400\text{ V}$, $I_C = 20\text{ A}$ $R_G = 10\ \Omega$, $V_{GE} = 15\text{ V}$, (see Figure 18)	-	290 185 475		μ J μ J μ J
$E_{on}^{(1)}$ E_{off} E_{ts}	Turn-on switching losses Turn-off switching losses Total switching losses	$V_{CC} = 400\text{ V}$, $I_C = 20\text{ A}$ $R_G = 10\ \Omega$, $V_{GE} = 15\text{ V}$, $T_J = 125\text{ }^\circ\text{C}$ (see Figure 18)	-	420 350 770	530	μ J μ J μ J

1. E_{on} is the turn-on losses when a typical diode is used in the test circuit in [Figure 18](#). If the IGBT is offered in a package with a co-pak diode, the co-pak diode is used as external diode. IGBTs and diode are at the same temperature (25 °C and 125 °C). E_{on} include diode recovery energy.

Table 9. Collector-emitter diode

Symbol	Parameter	Test conditions	Min.	Typ.	Max.	Unit
V_F	Forward on-voltage	$I_F = 20\text{ A}$ $I_F = 20\text{ A}$, $T_J = 125\text{ }^\circ\text{C}$	-	1.8 1.4	2.25	V V
t_{rr} Q_{rr} I_{rrm}	Reverse recovery time Reverse recovery charge Reverse recovery current	$I_F = 20\text{ A}$, $V_R = 50\text{ V}$, $di/dt = 100\text{ A}/\mu\text{s}$ (see Figure 19)	-	50 90 3	-	ns nC A
t_{rr} Q_{rr} I_{rrm}	Reverse recovery time Reverse recovery charge Reverse recovery current	$I_F = 20\text{ A}$, $V_R = 50\text{ V}$, $T_J = 125\text{ }^\circ\text{C}$, $di/dt = 100\text{ A}/\mu\text{s}$ (see Figure 19)	-	135 375 5.5	-	ns nC A

2.1 Electrical characteristics (curves)

Figure 2. Output characteristics

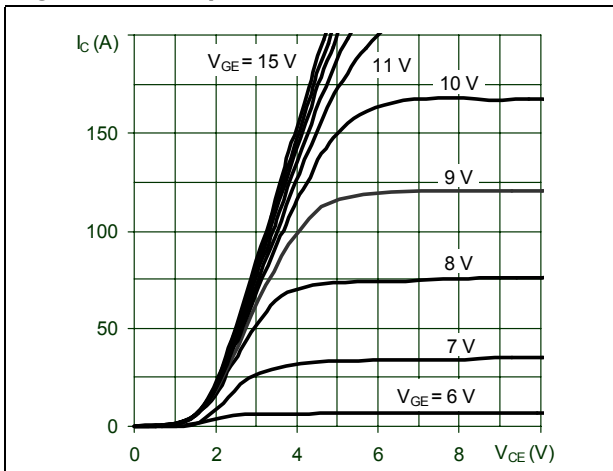

Figure 3. Transfer characteristics

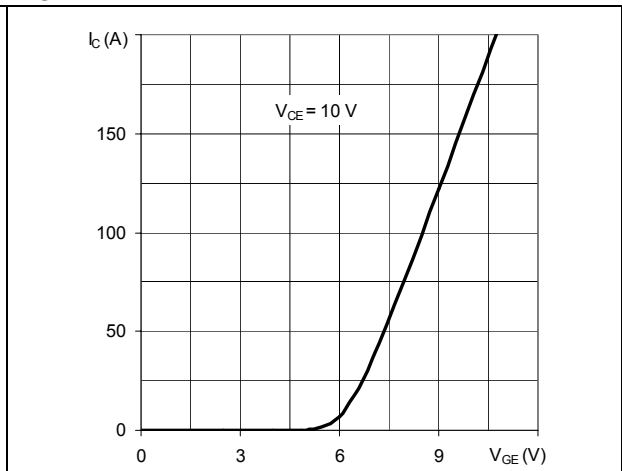

Figure 4. Normalized $V_{CE(sat)}$ vs. I_C

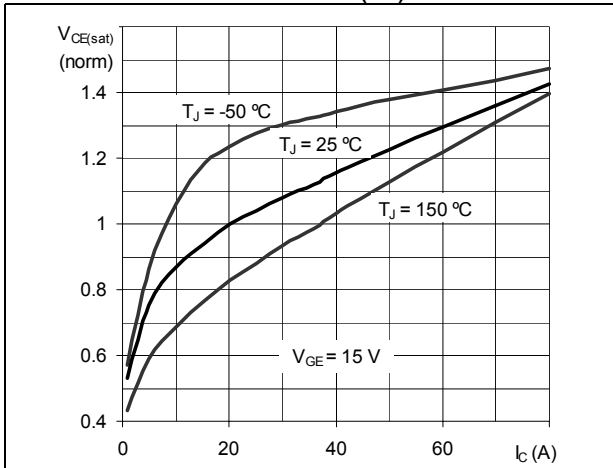

Figure 5. Normalized $V_{CE(sat)}$ vs. temperature

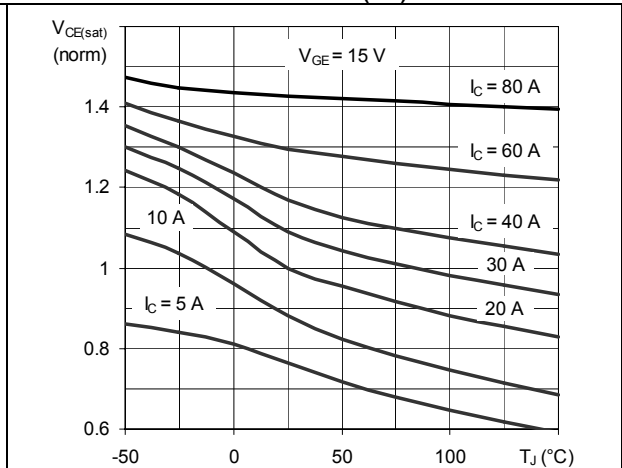

Figure 6. Normalized breakdown voltage vs. temperature

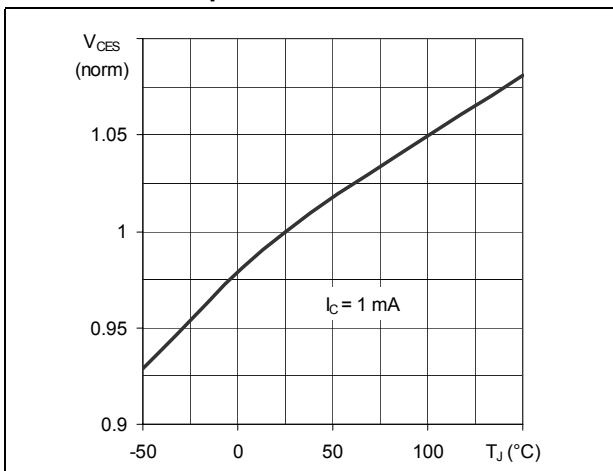

Figure 7. Normalized gate threshold voltage vs. temperature

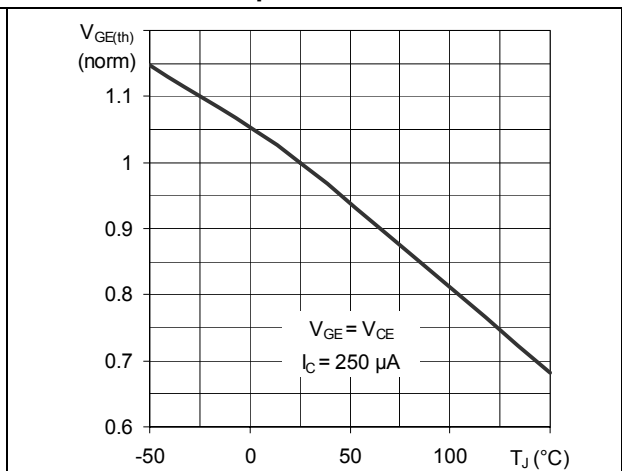

Figure 8. Gate charge vs. gate-emitter voltage

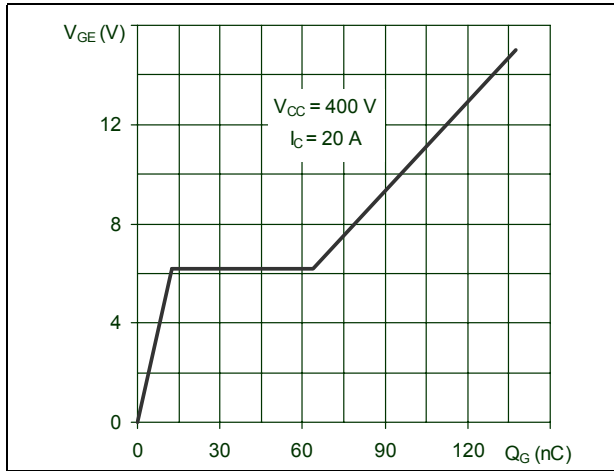

Figure 9. Capacitance variations

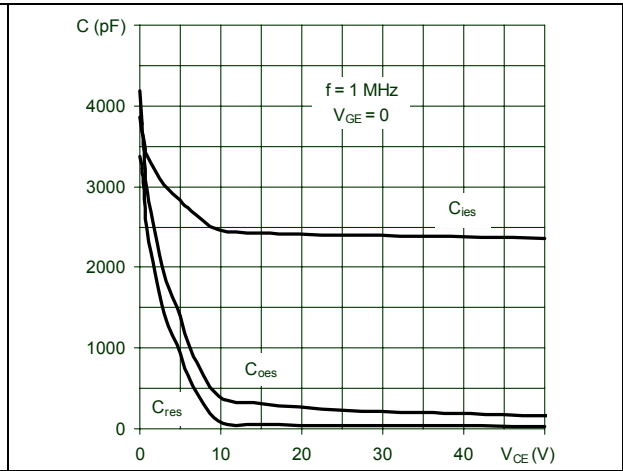

Figure 10. Switching losses vs temperature

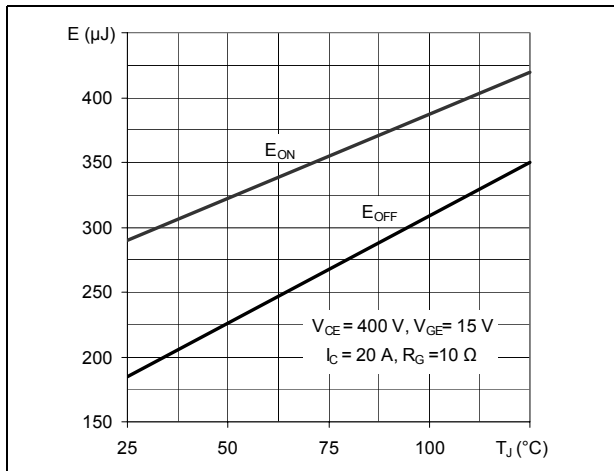

Figure 11. Switching losses vs. gate resistance

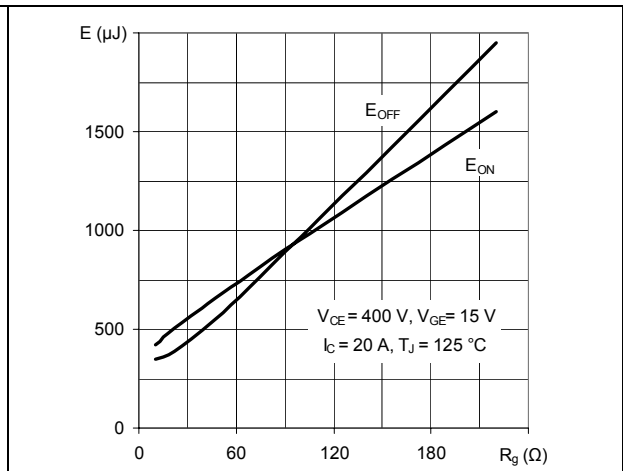

Figure 12. Switching losses vs. collector current

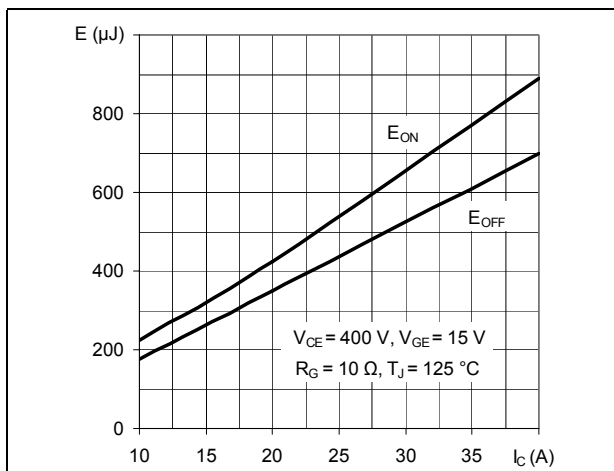

Figure 13. Turn-off SOA

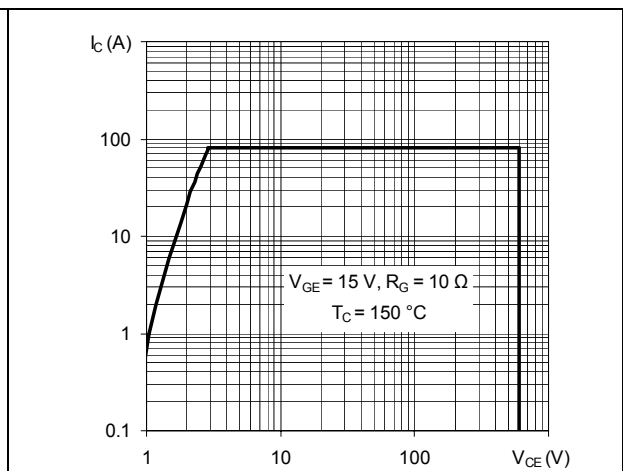

Figure 14. Diode forward on voltage

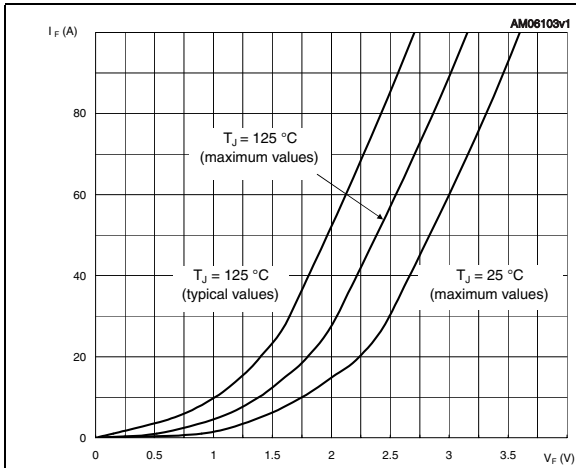
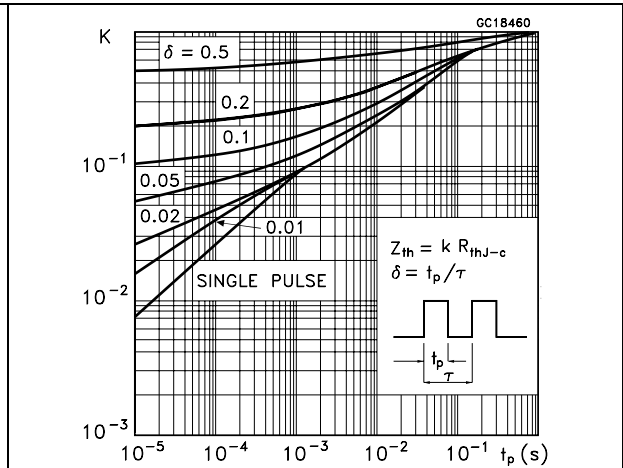

Figure 15. Thermal impedance



4 Package mechanical data

In order to meet environmental requirements, ST offers these devices in different grades of ECOPACK® packages, depending on their level of environmental compliance. ECOPACK® specifications, grade definitions and product status are available at: www.st.com. ECOPACK is an ST trademark.

TO-247 Mechanical data

Dim.	mm.		
	Min.	Typ	Max.
A	4.85		5.15
A1	2.20		2.60
b	1.0		1.40
b1	2.0		2.40
b2	3.0		3.40
c	0.40		0.80
D	19.85		20.15
E	15.45		15.75
e		5.45	
L	14.20		14.80
L1	3.70		4.30
L2		18.50	
øP	3.55		3.65
øR	4.50		5.50
S		5.50	

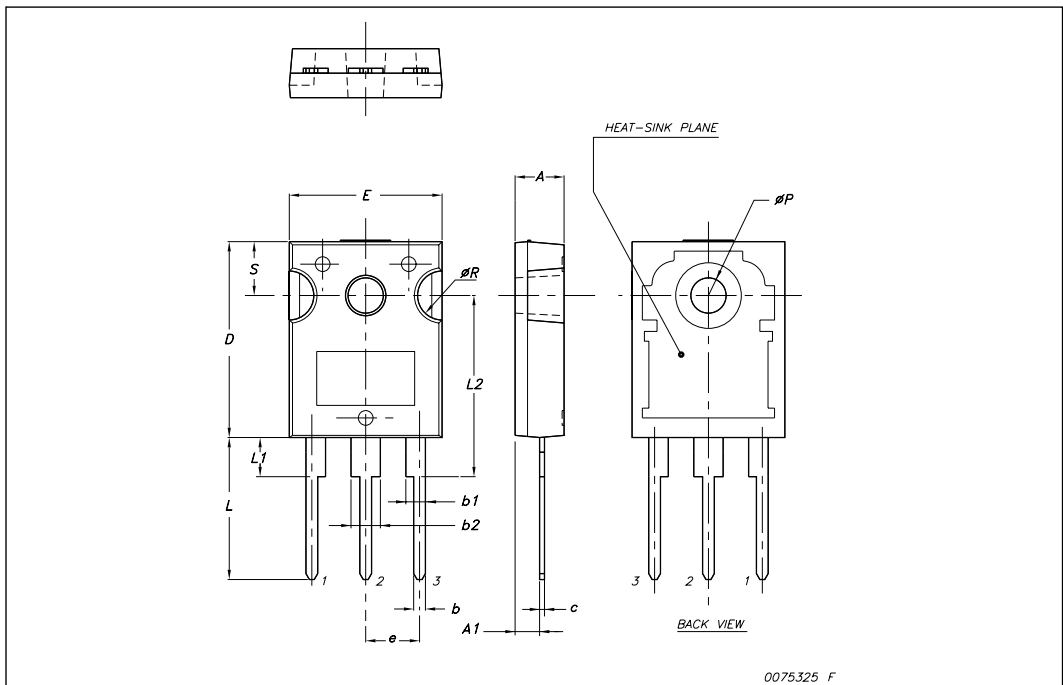

5 Revision history

Table 10. Document revision history

Date	Revision	Changes
14-Apr-2009	1	Initial release.
03-Aug-2009	2	Inserted dynamic parameters on Table 6 an Table 7 Document status promoted from preliminary data to datasheet
02-Sep-2009	3	Minor text changes throughout the document Removed watermark
30-Sep-2009	4	Inserted $V_{CE(sat)}$ grouping A, B and C (see Table 5: $V_{CE(sat)}$ classification)
10-May-2010	5	Inserted Section 2.1: Electrical characteristics (curves)

Please Read Carefully:

Information in this document is provided solely in connection with ST products. STMicroelectronics NV and its subsidiaries ("ST") reserve the right to make changes, corrections, modifications or improvements, to this document, and the products and services described herein at any time, without notice.

All ST products are sold pursuant to ST's terms and conditions of sale.

Purchasers are solely responsible for the choice, selection and use of the ST products and services described herein, and ST assumes no liability whatsoever relating to the choice, selection or use of the ST products and services described herein.

No license, express or implied, by estoppel or otherwise, to any intellectual property rights is granted under this document. If any part of this document refers to any third party products or services it shall not be deemed a license grant by ST for the use of such third party products or services, or any intellectual property contained therein or considered as a warranty covering the use in any manner whatsoever of such third party products or services or any intellectual property contained therein.

UNLESS OTHERWISE SET FORTH IN ST'S TERMS AND CONDITIONS OF SALE ST DISCLAIMS ANY EXPRESS OR IMPLIED WARRANTY WITH RESPECT TO THE USE AND/OR SALE OF ST PRODUCTS INCLUDING WITHOUT LIMITATION IMPLIED WARRANTIES OF MERCHANTABILITY, FITNESS FOR A PARTICULAR PURPOSE (AND THEIR EQUIVALENTS UNDER THE LAWS OF ANY JURISDICTION), OR INFRINGEMENT OF ANY PATENT, COPYRIGHT OR OTHER INTELLECTUAL PROPERTY RIGHT.

UNLESS EXPRESSLY APPROVED IN WRITING BY AN AUTHORIZED ST REPRESENTATIVE, ST PRODUCTS ARE NOT RECOMMENDED, AUTHORIZED OR WARRANTED FOR USE IN MILITARY, AIR CRAFT, SPACE, LIFE SAVING, OR LIFE SUSTAINING APPLICATIONS, NOR IN PRODUCTS OR SYSTEMS WHERE FAILURE OR MALFUNCTION MAY RESULT IN PERSONAL INJURY, DEATH, OR SEVERE PROPERTY OR ENVIRONMENTAL DAMAGE. ST PRODUCTS WHICH ARE NOT SPECIFIED AS "AUTOMOTIVE GRADE" MAY ONLY BE USED IN AUTOMOTIVE APPLICATIONS AT USER'S OWN RISK.

Resale of ST products with provisions different from the statements and/or technical features set forth in this document shall immediately void any warranty granted by ST for the ST product or service described herein and shall not create or extend in any manner whatsoever, any liability of ST.

ST and the ST logo are trademarks or registered trademarks of ST in various countries.

Information in this document supersedes and replaces all information previously supplied.

The ST logo is a registered trademark of STMicroelectronics. All other names are the property of their respective owners.

© 2010 STMicroelectronics - All rights reserved

STMicroelectronics group of companies

Australia - Belgium - Brazil - Canada - China - Czech Republic - Finland - France - Germany - Hong Kong - India - Israel - Italy - Japan - Malaysia - Malta - Morocco - Philippines - Singapore - Spain - Sweden - Switzerland - United Kingdom - United States of America

www.st.com