

I. Introduction

TM1638 is an IC dedicated to LED (light emitting diode display) drive control and equipped with a keypad scan interface. It integrates MCU digital interface, data latch, LED drive, and keypad scanning circuit. This product is reliable in quality, stable in performance and strong in interference resistance. It is mainly used for household electrical appliances (smart water heaters, microwave ovens, washing machines, air conditioners, electric stove), set-top boxes, electronic scale, smart meters and other digital tube or LED display devices.

II. Features

- CMOS technology
- 10 segments × 8 bits display
- Keypad scanning (8 × 3 bits)
- Brightness adjustment circuit (8-level adjustable duty ratio)
- Serial interfaces (CLK, STB, DIO)
- Oscillation mode: RC oscillation
- Built-in power-on reset circuit
- Package type: SOP28

III. Pin definition:

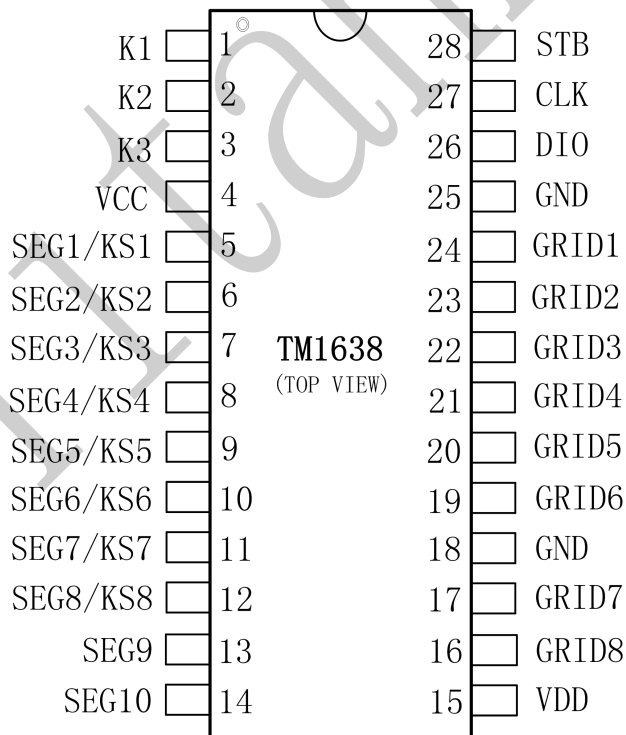

IV. Pin function:

Symbol	Pin Name	Pin ID	Description
DIO	Data input and output	26	Input serial data at rising edge of the clock, starting from lower bits. Output serial data at falling edge of the clock, starting from lower bits. During output, this is a PMOS open drain output.
CLK	Clock input	27	Read serial data at rising edge and output data at falling edge.
STB	Chip selection input	28	Initialize the serial interface at falling edge, then wait to receive instructions. The first byte after STB becomes low is considered as an instruction. When an instruction is being processed, other current processes are terminated. When STB is high, CLK is ignored.
K1~K3	keypad scanning signal input	1~3	The data input into this pin is latched at the end of display cycle
SGE1/KS1~SEG8/KS8	Output (segment)	5~12	Segment output (also used as keypad scanning output). This is a PMOS open-drain output
GRID1~GRID8	Output (bit)	24~19 17~16	Bit output. This is an NMOS open-drain output.
SEG9 ~ SEG10	Output (segment)	13~14	Segment output. This is a PMOS open drain output.
VDD	Logic Supply	4,15	Power +
GND	Logic GND	18,25	System GND

- ▲ **Note:** When DIO outputs data, it is an NMOS open drain output. To read the keypad, an external pull-up resistor should be provided to connect 1K-10K. The Company recommends a 10K pull up resistor. At falling edge of the clock, DIO controls the operation of NMOS, at which point, the reading is unstable until rising edge of the clock.

V. Description of Instructions:

The first byte input by DIO after the falling edge of STB is considered as an instruction. After decoding, obtain the topmost B7 and B6 bits to distinguish different instructions.

B7	B6	Instruction
0	1	Setting of Data Command
1	0	Setting of Display Control Command
1	1	Setting of Address Command

If STB is set high during instruction or data transmission, serial communication is initialized, and the instruction or data being transmitted is invalid (but the instruction or data transmitted before remains active.)

5.1 Setting of Data Command

This instruction is used to set data writing and reading. Bits B1 and B0 cannot set to 01 or 11.

MSB				LSB				Function	Description
B7	B6	B5	B4	B3	B2	B1	B0		
0	1	Unrelated item, fill 0				0	0	Setting of data read-write mode	Write data to the display register
0	1					1	0		Read key scanning data
0	1					0		Sett address increment mode	Auto increment
0	1					1			Fixed address
0	1					0		Test mode setting (for internal use)	Normal mode
0	1					1			Test mode

5.2 Setting of Address Command

MSB				LSB				Display address
B7	B6	B5	B4	B3	B2	B1	B0	
1	1	Unrelated item, fill 0		0	0	0	0	00H
1	1			0	0	0	1	01H
1	1			0	0	1	0	02H
1	1			0	0	1	1	03H
1	1			0	1	0	0	04H
1	1			0	1	0	1	05H
1	1			0	1	1	0	06H
1	1			0	1	1	1	07H
1	1			1	0	0	0	08H
1	1			1	0	0	1	09H
1	1			1	0	1	0	0AH
1	1			1	0	1	1	0BH
1	1			1	1	0	0	0CH
1	1			1	1	0	1	0DH
1	1			1	1	1	1	0EH
1	1			1	1	1	1	1

This instruction is used to set the address of the display register.

If the address is 10H or higher, data will be ignored until a valid address is set. On power-up, the address is set to 00H by default.

5.3 Display control

MSB				LSB				Function	Description
B7	B6	B5	B4	B3	B2	B1	B0		
1	0	Unrelated item, fill 0			0	0	0	Set the number of extinction	Set the pulse width to 1/16
1	0				0	0	1		Set the pulse width to 2/16
1	0				0	1	0		Set the pulse width to 4/16
1	0				0	1	1		Set the pulse width to 10/16
1	0				1	0	0		Set the pulse width to 11/16
1	0				1	0	1		Set the pulse width to 12/16
1	0				1	1	0		Set the pulse width to 13/16
1	0				1	1	1		Set the pulse width to 14/16
1	0				0			Setting of display switch	Display Off
1	0			1			Display ON		

VI. Address of display register:

The register stores data transmitted through the serial interface from an external device to TM1638, or, to the address of 16 bytes ranging from 00H-0FH, each corresponding to the LEDs connected with the chip SEG and GRID pins, as assigned below:

LED display data are written in an ascending order of both display address and data byte.

SEG1	SEG2	SEG3	SEG4	SEG5	SEG6	SEG7	SEG8	SEG9	SEG10	X	X	X	X	X	X	
xxHL (low four)				xxHU (high four)				xxHL (low four)				xxHU (high four)				
B0	B1	B2	B3	B4	B5	B6	B7	B0	B1	B2	B3	B4	B5	B6	B7	
00HL				00HU				01HL				01HU				GRID1
02HL				02HU				03HL				03HU				GRID2
04HL				04HU				05HL				05HU				GRID3
06HL				06HU				07HL				07HU				GRID4
08HL				08HU				09HL				09HU				GRID5
0AHL				0AHU				0BHL				0BHU				GRID6
0CHL				0CHU				0DHL				0DHU				GRID7

0EHL	0EHU	0FHL	0FHU	GRID8
------	------	------	------	--------------

Figure (2)

▲ Note: The moment the display register of the chip is powered on, the values stored inside may be random, at which point, customers may directly send a command to turn on the screen.

Messy codes are likely to appear. Considering that, the company advise customers to clear the display register upon power-on, i.e., writing 0x00 into all the 16-byte memory addresses (00H-0FH).

VII. Display

1. Driving common cathode LEDs:

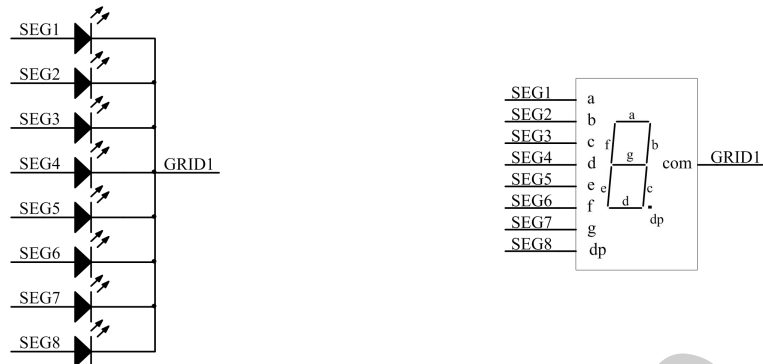

Figure (7)

Figure 7 is a diagram for the wiring of common cathode LEDs. To display 0 off the LED segment display, customers only need to write 0x3F to the 00H (GRID1) address starting from lower bits, at which point, 00H corresponds to the data in SEG1-SEG8 as shown in the table below.

SEG8	SEG7	SEG6	SEG5	SEG4	SEG3	SEG2	SEG1	
0	0	1	1	1	1	1	1	GRID1(00H)
B7	B6	B5	B4	B3	B2	B1	B0	

2. Driving common anode LEDs:



Figure (8)

Figure 8 is a diagram for the wiring of common anode LEDs. To display 0 off the LED segment display, customers only need to write 01H into 00H (GRID1), 02H (GRID2), 04H (GRID3), 06H (GRID4), 08H (GRID5), and 0AH (GRID6), and 00H into 0CH (GRID7) and 0EH (GRID8). SEG1-SEG8 correspond to the data table below.

SEG8	SEG7	SEG6	SEG5	SEG4	SEG3	SEG2	SEG1	
0	0	0	0	0	0	0	1	GRID1(00H)
0	0	0	0	0	0	0	1	GRID2(02H)
0	0	0	0	0	0	0	1	GRID3(04H)
0	0	0	0	0	0	0	1	GRID4(06H)
0	0	0	0	0	0	0	1	GRID5(08H)

0	0	0	0	0	0	0	1	GRID6(0AH)
0	0	0	0	0	0	0	0	GRID7(0CH)
0	0	0	0	0	0	0	0	GRID8(0EH)
B7	B6	B5	B4	B3	B2	B1	B0	

▲ Note: To drive common cathode LEDs or common anode LEDs, SEG pins can only be connected with LED anode, and GRID, only with LED cathode. Do not connect them in reverse direction.

VIII. Keypad scanning and key combination:

The keypad scanning matrix is 3 × 8bit, as shown in Figure (3) below:

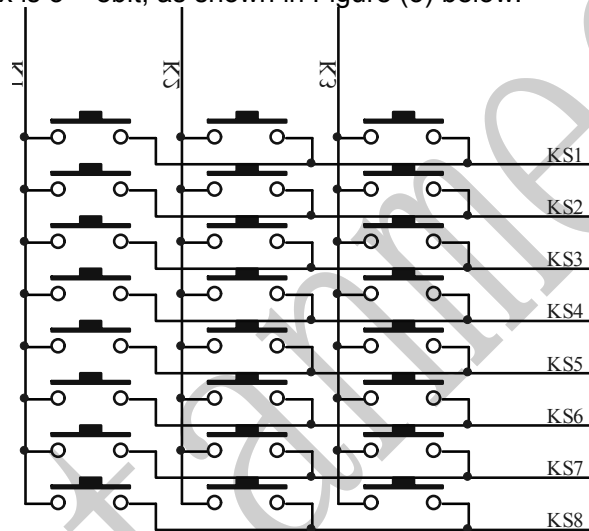

Figure (3)

The storage address for keypad data is shown in (4). Upon a key reading command, the device starts to read key data BYTE1-BYTE4. Data already read will be output starting from lower bits. When a key corresponding to a pin of chips K and KS is pressed, the BIT corresponding to the byte is 1.

B0	B1	B2	B3	B4	B5	B6	B7	
K3	K2	K1	X	K3	K2	K1	X	
KS1			KS2				BYTE1	
KS3			KS4				BYTE2	
KS5			KS6				BYTE3	
KS7			KS8				BYTE4	

Figure (4)

▲ Note: 1, TM1638 can be read up to four bytes only.

2. Data are read in order from BYTE1 to BYTE4 without skipping any byte. For example: When the key corresponding to K2 and KS8 on a hardware, it is impossible to know the data unless and until the data from the key is read down to the fifth BIT of the fourth byte. When two keys corresponding to K1 and KS8 as well as K2 and KS8 respectively are pressed simultaneously, the data read from B5 and B6 are 1 at BYTE4.

3. A combination key can only be formed on the same KS pins and different K pins. It is impossible to form a combination key on the same K pin but different KS pins.

Keypad scan and combination keys:

(1) Keypad scan: keypad scanning is automatically done by TM1638 without user control. Users only need to read key codes according to time sequence. It takes a display cycle to scan keypad and a display cycle takes about $T = 4.7\text{ms}$. During this 4.7ms , if two different keys are pressed, the key code read in both times is the one of the key pressed first.

(2) Combination keys

Unusual problems with combination keys: SEG1/KS1-SEG8/KS8 are for combined use for display and keypad scanning. Take Figure (12) for example, to turn D1 on and D2 off, we have to make sure SEG1 is in the status of "0" and SEG2, the status of "1". If S1 and S2 are pressed simultaneously, it is to the effect that SEG1 and SEG2 are short-circuited, then D1 and D2 are turned on.

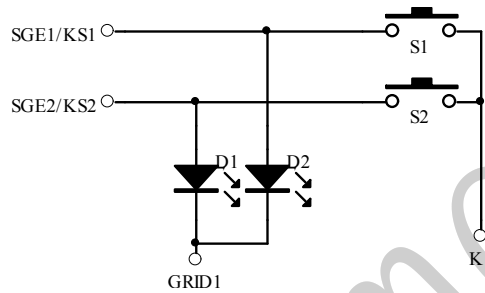

Figure (12)

Solution:

1. In terms of hardware, it is advisable to arrange the keys to be pressed at the same time on different K line, as shown in Figure (13).

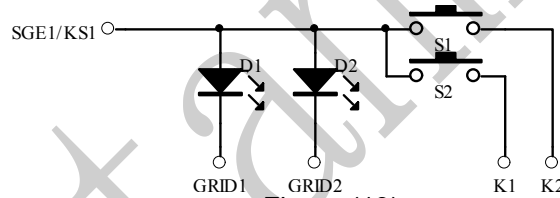

Figure (13)

2. Series diodes are shown in Figure (14).

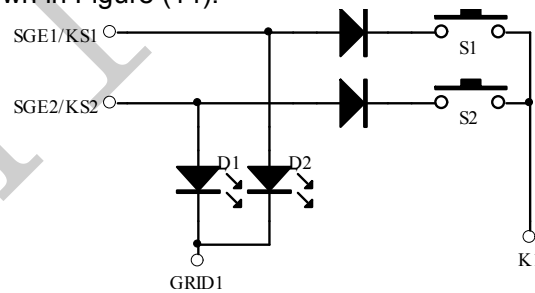

Figure (14)

▲ Note: It is recommended to form combination keys on the same KS but different Ks.

IX. Transmission format of serial data:

a BIT is read and received at rising edge of the clock.

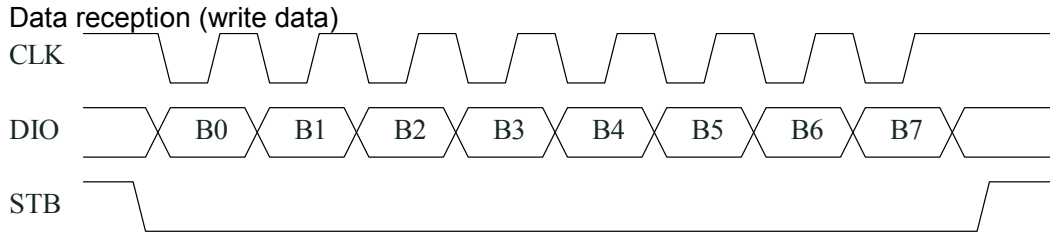

Figure (5)

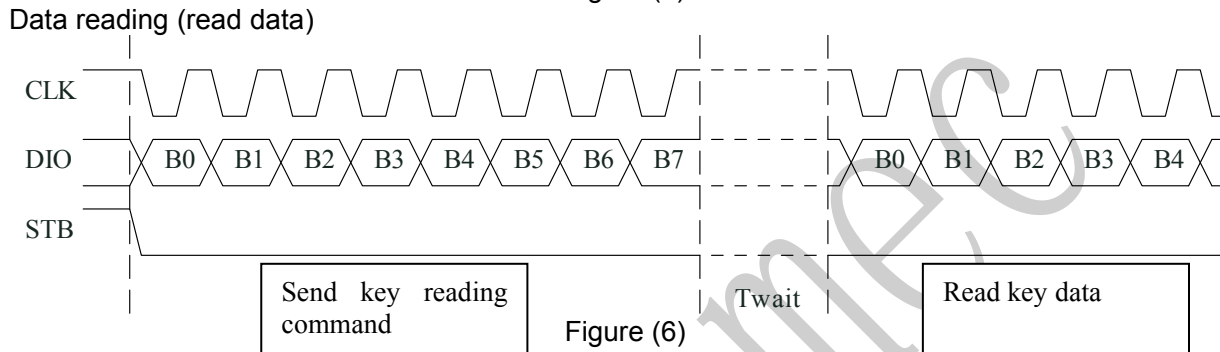

Figure (6)

▲ Note: 1. When data is read, it takes a waiting time T_{wait} (minimum $2\mu S$) from instruction setting at the eighth rising edge of the serial clock CLK to data reading at falling edge of the CLK. See the Timing Characteristics table for specific parameters.

X. Transmission of serial data in application

(1) Address increment mode

If address automatically increments by 1, the essence of address setting is to set the starting address where a data stream transmitted is stored. After the command word of the Starting Address has been sent, "STB" does not need to be set high to transmit data immediately thereafter, given 16 BYTES at most. It is advisable to set STB high after data transmission.

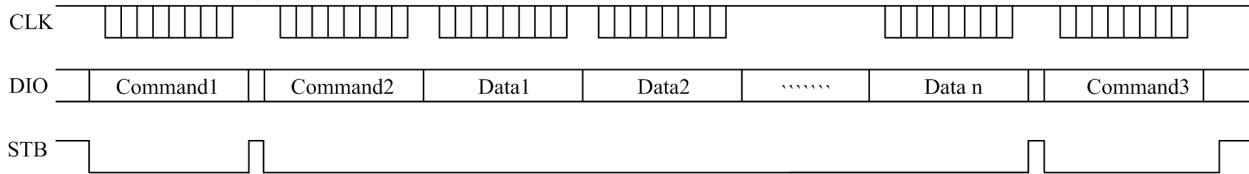

Command1: Set data command

Command2: Set display address

Data1~n: Transmit display data to the Command3 address and the following addresses (16 bytes at most)

Command3: Set display control command

(2) Fixed Address Mode

If fixed address mode is adopted, the essence of address setting is to set the address where 1 BYTE data to be transmitted is stored. After transmission of address, it is not necessary to set "STB" high to transmit 1BYTE data immediately thereafter. It is advisable to set STB high after data transmission. Then users may set the address where the second data is stored. After transmission of date up to 16 BYTES at most, "STB" is set high.

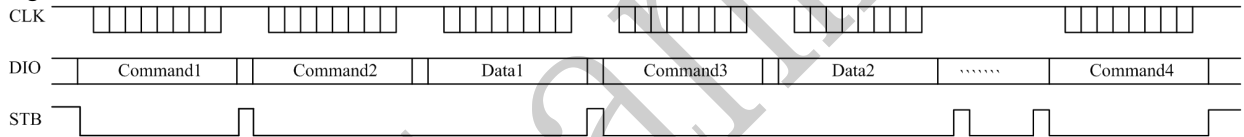

Command1: Set data command

Command2: Set display address1

Data1: Transmit display data 1 to Command3 address

Command3: Set display address 2

Data2: Transmit display data 2 to Command4 address

Command4: Set display control command

(3) Timing for key reading

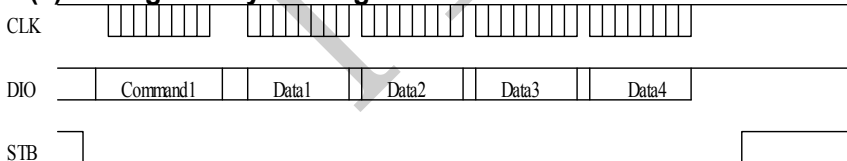

Command1: Set key reading command

Data1 ~ 4: read key data

(4) Flowchart for program design in the modes of auto address increment by 1 and fixed address:
Flowchart for program design in the mode of auto address increment by 1:

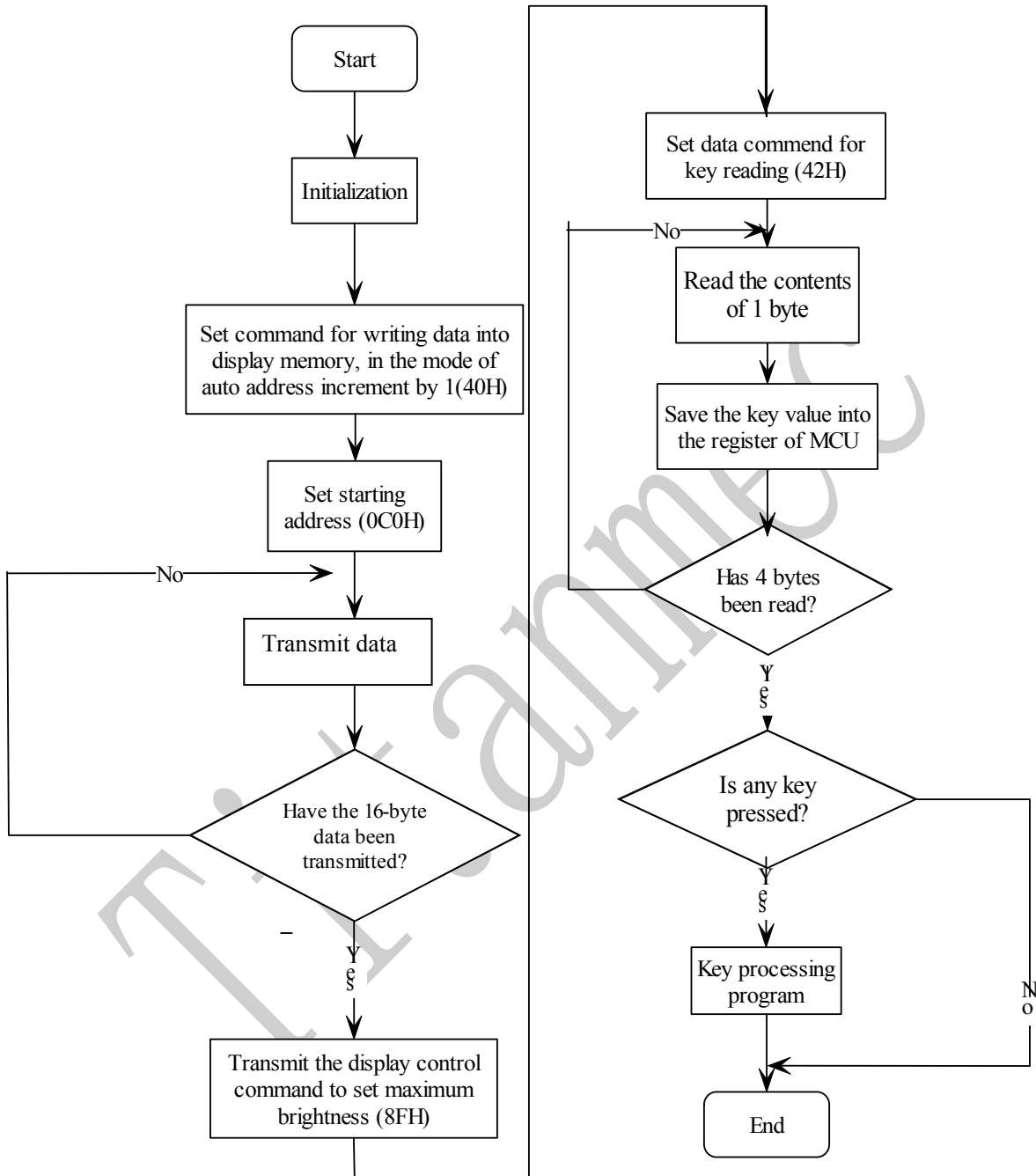

Flowchart for program design in the mode of fixed address:

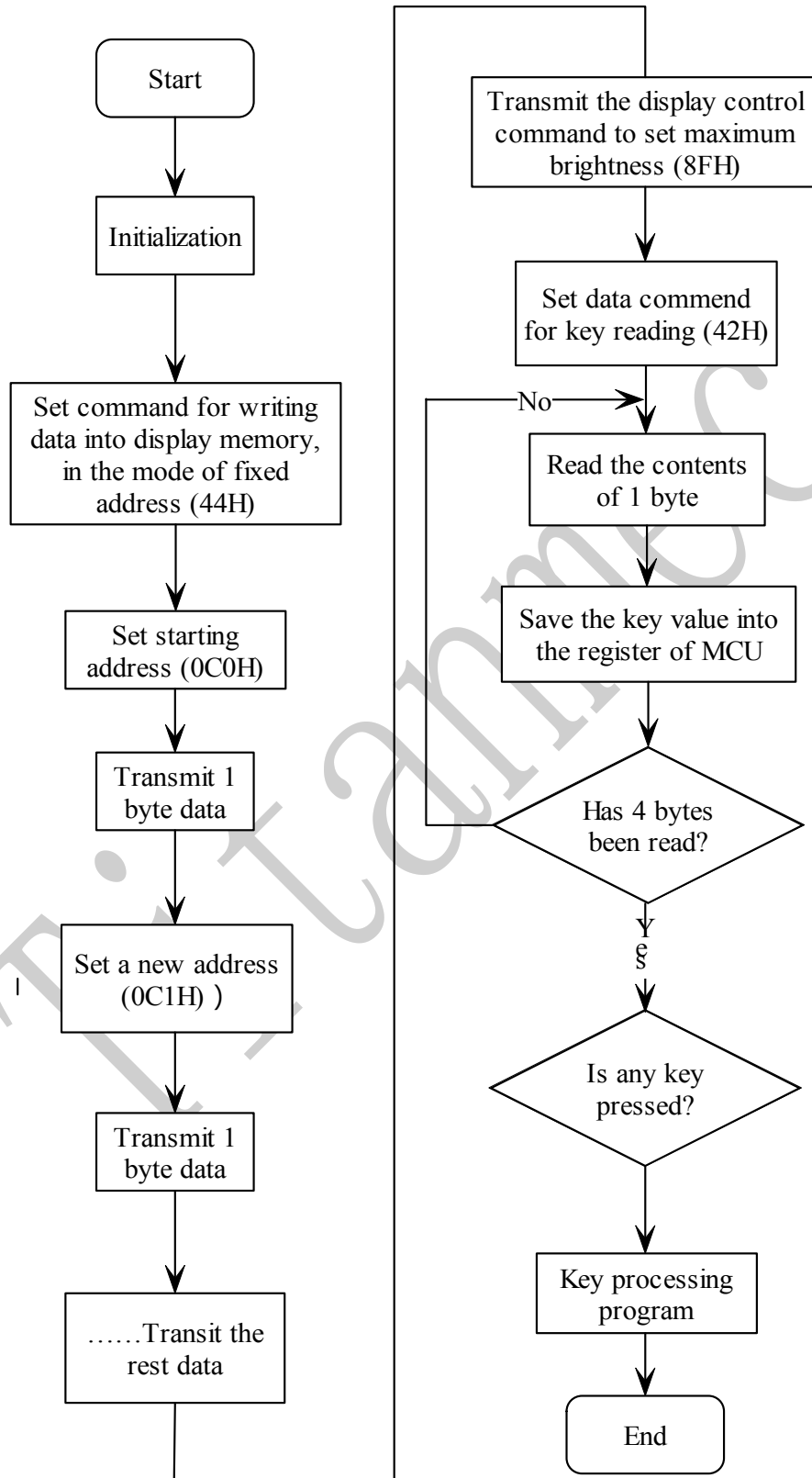

XI. Application Circuit:

Hardware circuit diagram for TM1638 to drive a common cathode LED screen

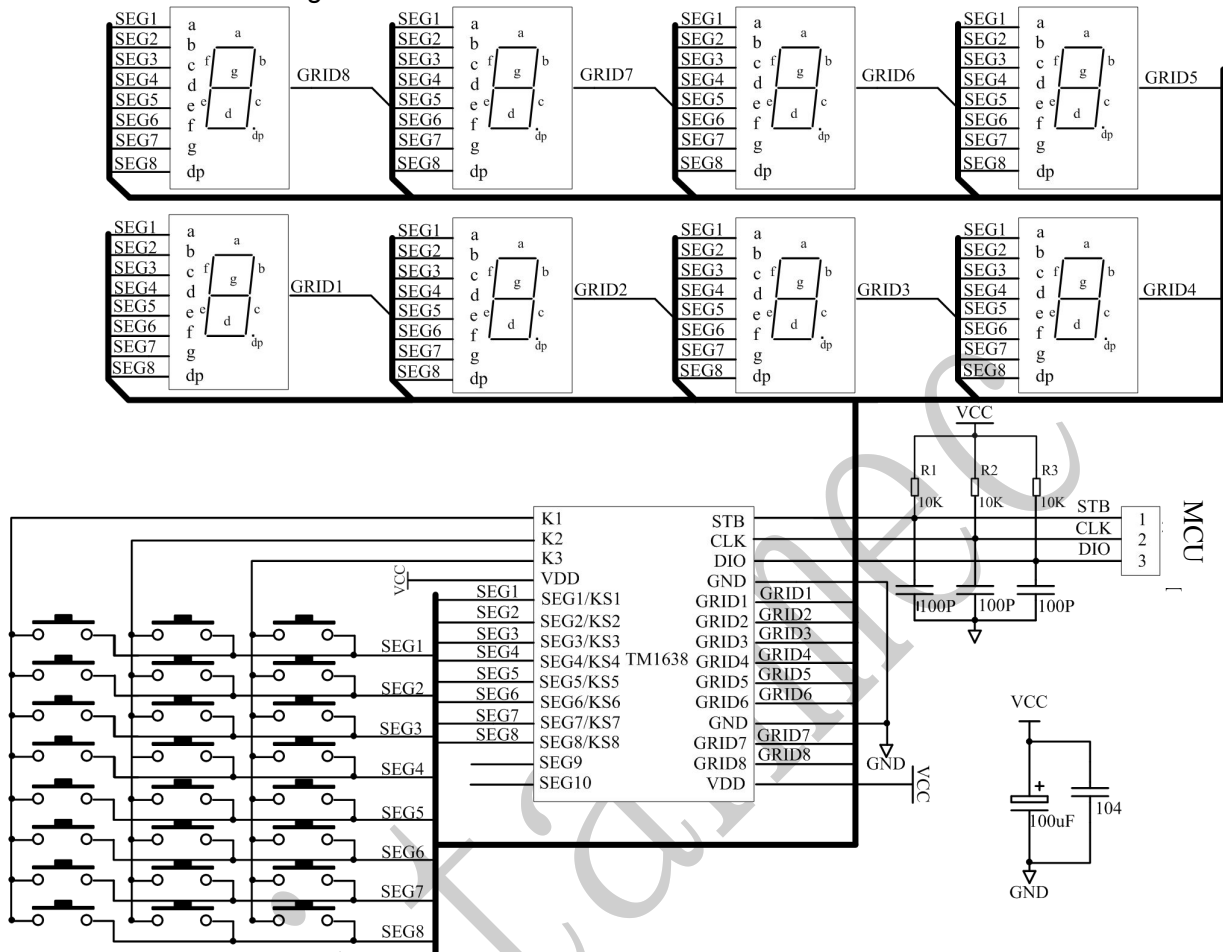

Hardware circuit diagram for TM1638 to drive a common anode LED screen

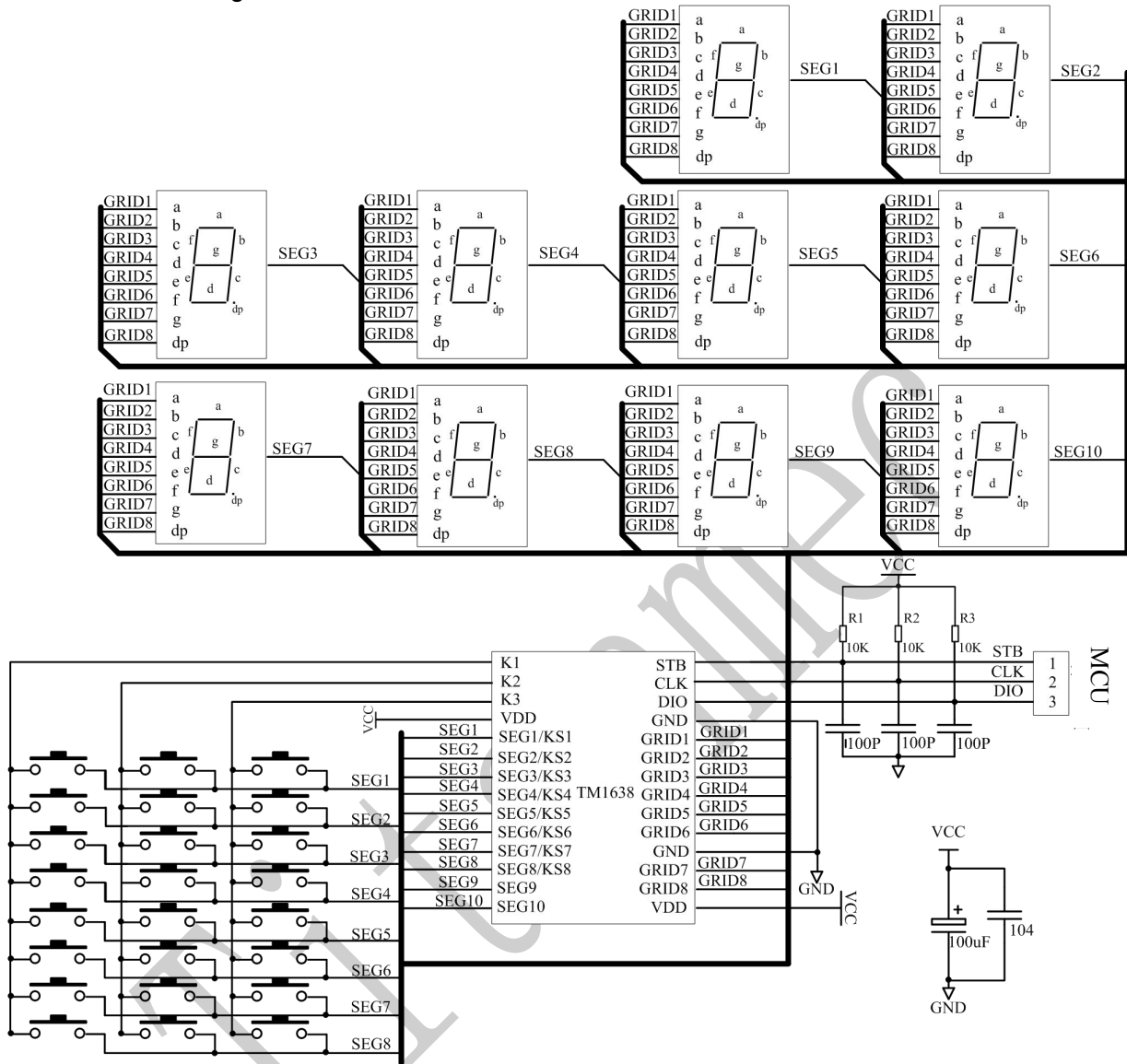

- ▲ Note:
1. During PCB board wiring, the filter capacitor between VDD and GND shall be placed as close as possible to TM1638 to strengthen the filtering effect.
 2. The three 100P capacitors connected to the three communication ports, DIO, CLK, and STB will reduce interference with the communication ports.
 3. Considering the turn-on voltage drop of blue digital led display is about 3V, the power supply for TM1638 should be 5V.

XII Electrical Parameters:

Limit parameter (Ta = 25 °C, Vss = 0 V)

Parameter	Symbol	Scope	Unit
Logic Supply Voltage	VDD	-0.5~+7.0	V
Logic input voltage	VI1	-0.5 ~ VDD + 0.5	V
LED Seg drives output current	IO1	-50	mA
LED Grid drives output current	IO2	+200	mA
Power loss	PD	400	mW
Operating temperature	Topt	-40 ~ +80	°C
Storage temperature	Tstg	-65~+150	°C

Normal operating range (Ta = -20 ~ + 70 °C, Vss = 0 V)

Parameter	Symbol	Minimum	Typical	Maximum	Unit	Test Conditions
Logic Supply Voltage	VDD		5		V	-
High-level input voltage	VIH	0.7 VDD	-	VDD	V	-
Low-level input voltage	VIL	0	-	0.3 VDD	V	-

Electrical Characteristics (Ta = -20 ~ + 70 °C, VDD = 4.5 ~ 5.5 V, Vss = 0 V)

Parameter	Symbol	Minimum	Typical	Maximum	Unit	Test Conditions
SEG drives current draw	Ioh1	20	25	40	mA	SGE1~SEG10 Vo = VDD-2V
	Ioh2	20	30	50	mA	SGE1~SEG10 Vo = VDD-3V
GRID drives sink current	IOL1	80	140	-	mA	GRID1-GRID8 Vo=0.3V

Output pull-down resistance	RL		10		KΩ	K1~K3
Input current	II	-	-	±1	μA	VI = VDD / VSS
High-level input voltage	VIH	0.7 VDD	-		V	CLK, DI0, STB
Low-level input voltage	VIL	-	-	0.3 VDD	V	CLK, DI0, STB
Lagging voltage	VH	-	0.35	-	V	CLK, DI0, STB
Dynamic current loss	IDDdyn	-	-	5	mA	No load, Display Off

Switching Characteristics (Ta = -20 ~ + 70 °C, VDD = 4.5 ~ 5.5 V)

Parameter	Symbol	Minimum	Typical	Maximum	Unit	Test Conditions	
Oscillation frequency	fosc	-	500	-	KHz	R = 16.5 KΩ	
Transmission delay time	tPLZ	-	-	300	ns	CLK → DIO	
	tPZL	-	-	100	ns	CL = 15pF, RL = 10K Ω	
Rise Time	TTZH 1	-	-	2	μs	CL = 300pF	SEG1 ~ SEG10
Fall Time	TTHZ	-	-	120	μs	CL = 300pF, SEGN, GRIDN	
Maximum clock frequency	Fmax	-	-	1	MHz	Duty ratio=50%	
Input capacitance	CI	-	-	15	pF	-	

Timing Characteristics (Ta = -20 ~ + 70 °C, VDD = 4.5 ~ 5.5 V)

Parameter	Symbol	Minimum	Typical	Maximum	Unit	Test Conditions
Clock pulse width	PWCLK	400	-	-	ns	-
Strobing pulse width	PWSTB	1	-	-	µs	-
Data setup time	tSETUP	100	-	-	ns	-
Data Hold Time	tHOLD	100	-	-	ns	-
CLK → STB time	tCLK STB	1	-	-	µs	CLK↑→STB↑
Waiting time	tWAIT	1	-	-	µs	CLK↑→CLK↓

Timing Waveforms:

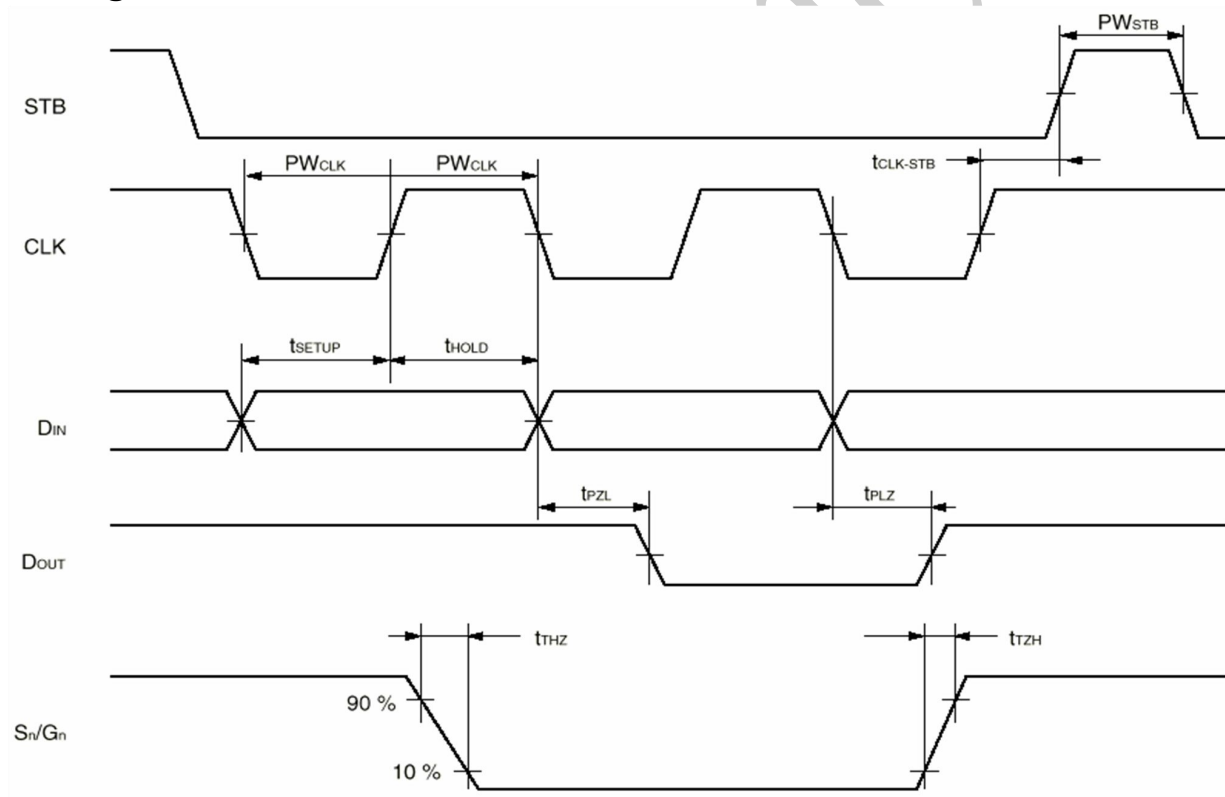

XIII. Package size

Package size for SOP28 :

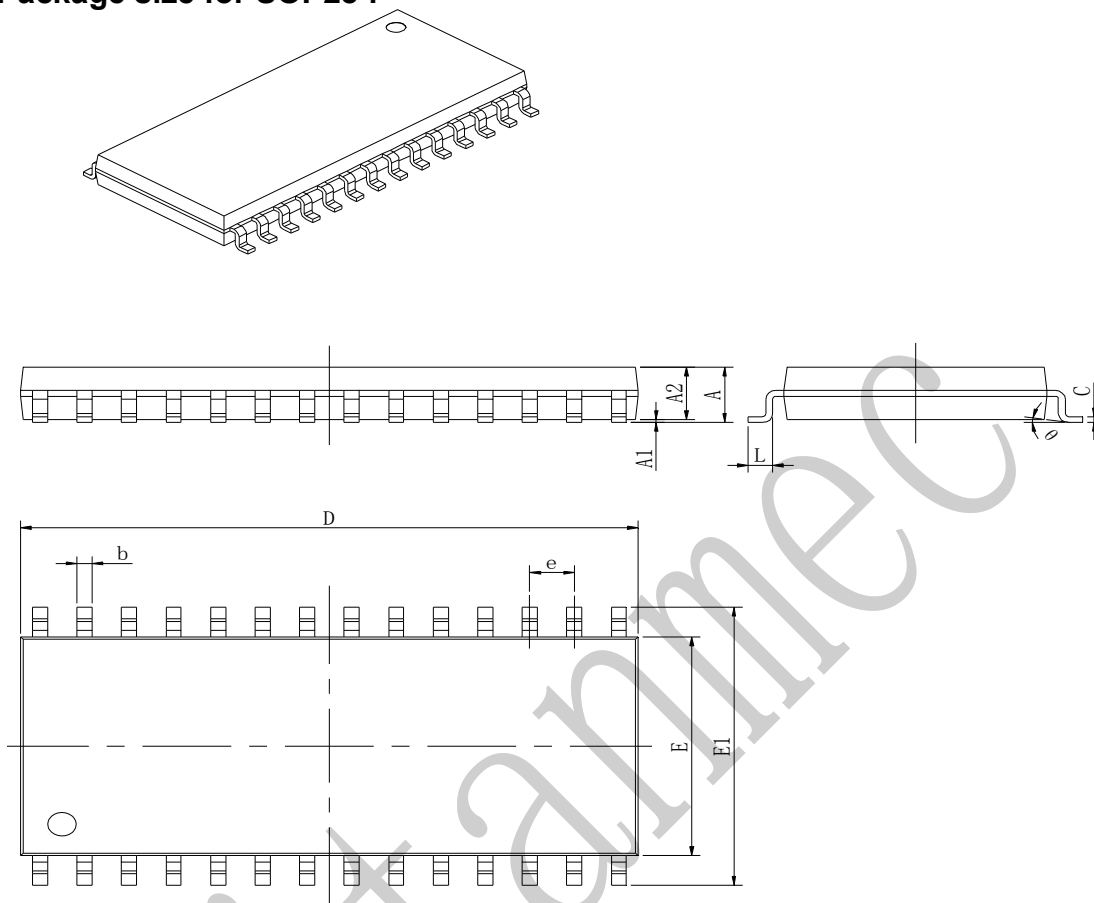

Symbol	Unit: mm		Unit: Inch	
	Minimum	Maximum	Minimum	Maximum
A	2.350	2.65	0.093	0.104
A1	0.10	0.3	0.004	0.012
A2	2.290	2.5	0.090	0.098
b	0.330	0.51	0.013	0.020
c	0.204	0.33	0.008	0.013
D	17.70	18.10	0.697	0.713
E	7.40	7.70	0.291	0.303
E1	10.21	10.61	0.402	0.418
e	1.270(BSC)		0.050(BSC)	
L	0.4	1.27	0.016	0.050
θ	0°	8°	0°	8°

All specs and applications shown above are subject to change without prior notice.