

# ET-5050W-3F1W

## Cool White

Ultra high luminous efficacy, combined with the flexibility in design due to its slim and miniature size, PLCC LED Series are optimized to be used as lighting for building.

### Features

- High luminous Intensity and high efficiency
- Based on InGaN / GaN technology
- Wide viewing angle : 120°
- Excellent performance and visibility
- Suitable for all SMT assembly methods
- IR reflow process compatible
- Environmental friendly; RoHS compliance

### Typical Applications

- Signal and Symbol Luminaire
- Indoor and Outdoor Displays
- Backlighting (illuminated advertising, general lighting)
- Interior Automotive Lighting

---

## Table of Contents

Product Nomenclature .....	2
Environmental Compliance .....	2
LED Package Dimensions and Polarity .....	3
Absolute Maximum Ratings .....	4
Luminous Intensity Characteristics .....	5
Forward Voltage Characteristics .....	5
JEDEC Information .....	6
Reliability Items and Failure Measures .....	7
Color Spectrum and Radiation Pattern.....	8
Optical & Electrical Characteristics .....	9
Product Soldering Instructions .....	11
Product Packaging Information .....	13
Precaution for Use .....	15
Forward Voltage Ranks.....	17
Luminous Intensity Ranks.....	17
CIE Chromaticity Diagram .....	18
Color Bin .....	19

## Product Nomenclature

The following table describes the available color, package size, and chip quantity.

< Table 1 PLCC 5050 series Nomenclature >

**E T – 5050 W – 3 F 1 W**  
**X1                      X2                      X3                      X4 X5 X6 X7**

X1 LED Item		X2 Package Type		X3 Emitting Color		X4 Chip Quantity		X5~X6 Serial No.	X7 Feature	
Code	Type	Code	Type	Code	Type	Code	Type		Code	Type
Edison Top LED	3528	3.5x2.8mm	W	Cool White	1	1pcs			W	White surface
		5050	5.0x5.0mm	H	Neutral White	3	3pcs		B	Black surface
			X	Warm White	A	0.5W		D	Black housing	
			R	Red	B	1W				
			A	Amber (590nm)						
			T	True Green						
			B	Blue						
		RTB	RGB 3 chips							

## Environmental Compliance

PLCC 5050 series are compliant to the Restriction of Hazardous Substances Directive or RoHS. The restricted materials including lead, mercury cadmium hexavalent chromium, polybrominated biphenyls (PBB) and polybrominated diphenyl ether (PBDE) are not used in PLCC 5050 series to provide an environmentally friendly product to the customers.

## LED Package Dimensions and Polarity

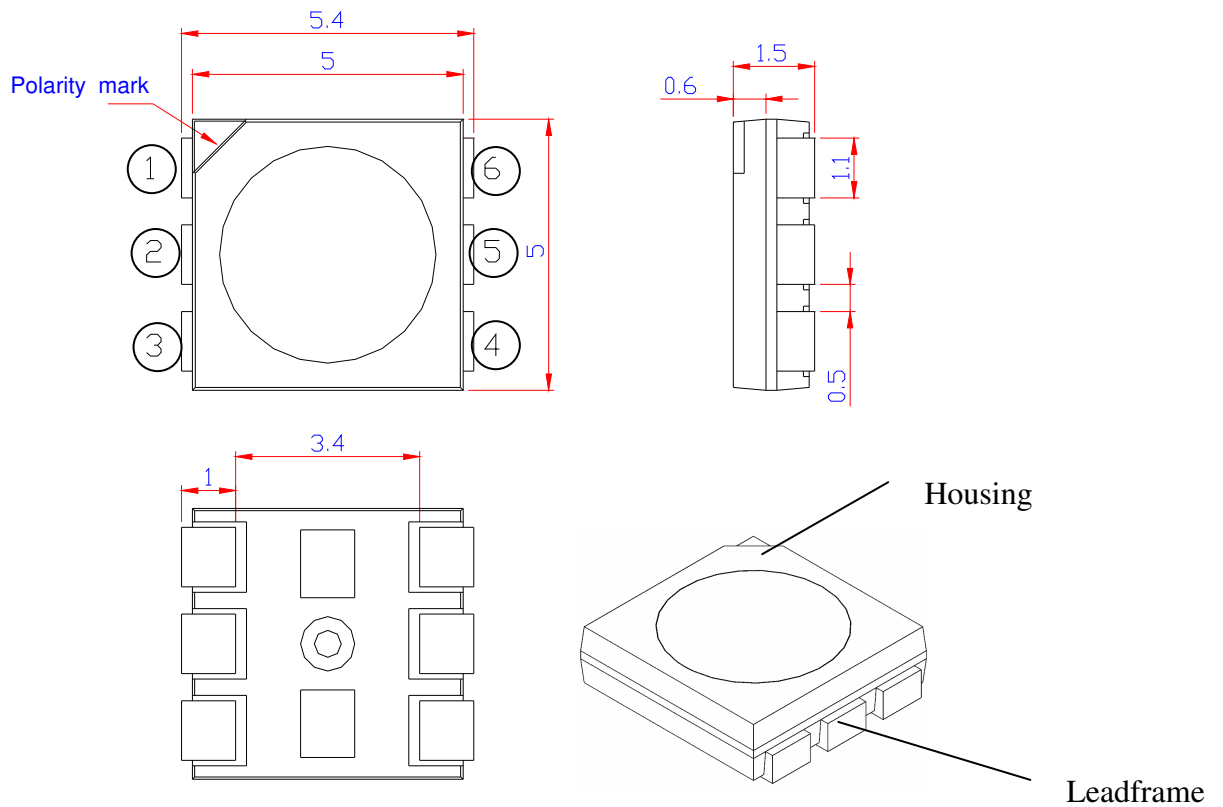

< Figure 1 PLCC 5050 series dimensions >

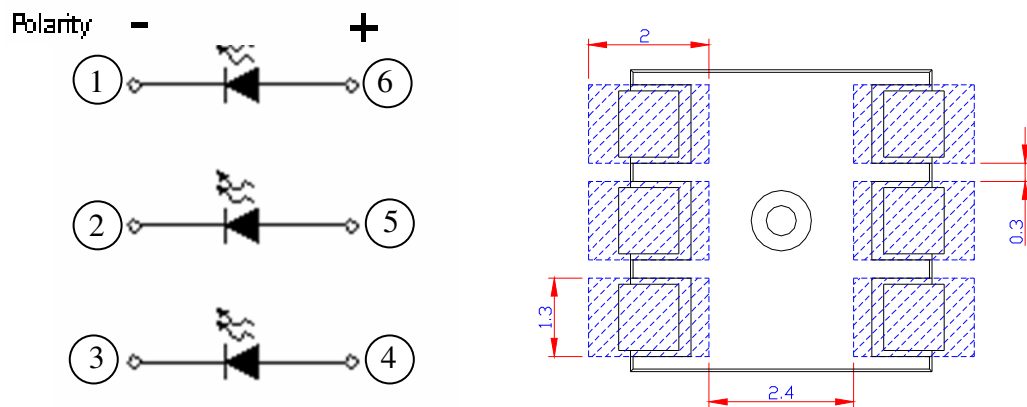

< Figure 2 PLCC 5050 series circuit diagram and recommended soldering pad >

### Notes:

1. All dimensions are in mm.
2. Tolerance :  $\pm 0.2$  mm

### Absolute Maximum Ratings

The following table describes absolute maximum ratings of PLCC 5050 series.

< Table 2 Absolute maximum ratings for PLCC 5050 series >

Parameter	Rating	Unit	Symbol
Forward Current	30	mA	$I_F$
Pulse Forward Current ( $t_p \leq 100\mu s$ , Duty cycle=0.25)	100	mA	
Reverse Voltage	5	V	$V_R$
Forward Voltage	3.8	V	$V_F$
Power Dissipation	115	mW	
LED Junction Temperature	125	°C	$T_J$
Operating Temperature	-30 ~ +85	°C	
Storage Temperature	-40 ~ +100	°C	
Soldering Temperature	255~260	°C	
Manual Soldering at 350°C (Max.)	3	Sec	

**Notes:**

1. Proper current derating must be observed to maintain junction temperature below the maximum at all time.
2. LEDs are not designed to be driven in reverse bias.
3.  $t_p$ : Pulse width time

### Luminous Intensity Characteristics

The following table describes luminous intensity of PLCC 5050 series.

< Table 3 Luminous intensity characteristics at  $I_F=20\text{mA}$  and  $T_a=25^\circ\text{C}$  for PLCC 5050 series >

Part Name	Color	Luminous intensity			Luminous Flux Typ.(lm)
		Min.	Typ.	Max.	
ET-5050W-3F1W	Cool White	--	5,800	--	17.4lm

**Note:**

1. Luminous intensity is measured with an accuracy of  $\pm 10\%$ .

### Forward Voltage Characteristics

The following table describes forward voltage of PLCC 5050 series

< Table 4 Forward voltage characteristics at  $I_F=20\text{mA}$  and  $T_a=25^\circ\text{C}$  for PLCC 5050 >

Part Name	Color	$V_F$			Unit
		Min.	Typ.	Max.	
ET-5050W-3F1W	Cool White	2.8	--	3.8	V

**Note:**

1. Forward Voltage is measured with an accuracy of  $\pm 0.1\text{V}$

### Color Temperature Characteristics $T_J=25^\circ\text{C}$

< Table 5 Color Rendering Index Characteristics at  $T_J=25^\circ\text{C}$  for PLCC 5050 series >

Part Name	Color	CRI
		Typ
ET-5050W-3F1W	Cool White	65

**Note:**

1. CRI is measured with an accuracy of  $\pm 5$

## JEDEC Information

JEDEC is used to determine what classification level should be used for initial reliability qualification. Once identified, the LEDs can be properly packaged, stored and handled to avoid subsequent thermal and mechanical damage during the assembly solder attachment and/or repair operation. The present moisture sensitivity standard contains six levels, the lower the level, the longer the devices floor life. PLCC 5050 series are certified at level 2a. This means PLCC 5050 series have a floor life of 4 weeks before PLCC 5050 series need to re-baked.

< Table 6 JEDEC characteristics for PLCC 5050 series >

Level	Floor Life		Soak Requirements			
	Time	Condition	Standard Time (hours)	Condition	Accelerated Environment Time (hours)	Condition
2a	4 weeks	$\leq 30^{\circ}\text{C}$ / 60% RH	696 +5/-0	$30^{\circ}\text{C}$ / 60% RH	120 +1/-0	$60^{\circ}\text{C}$ / 60% RH

Level	Floor Life		Soak Requirements			
	Time	Condition	Standard Time(hours)	Condition	Accelerated Equivalent Time(hours)	Condition
1	Unlimited	$\leq 30^{\circ}\text{C}/85\%$ RH	168 +5/-0	$85^{\circ}\text{C}/85\%$ RH		
2	1 year	$\leq 30^{\circ}\text{C}/60\%$ RH	168 +5/-0	$85^{\circ}\text{C}/60\%$ RH		
2a	4 weeks	$\leq 30^{\circ}\text{C}/60\%$ RH	696 <sup>1</sup> +5/-0	$30^{\circ}\text{C}/60\%$ RH	120 +1/-0	$60^{\circ}\text{C}/60\%$ RH
3	168 hours	$\leq 30^{\circ}\text{C}/60\%$ RH	192 <sup>1</sup> +5/-0	$30^{\circ}\text{C}/60\%$ RH	40 +5/-0	$60^{\circ}\text{C}/60\%$ RH
4	72 hours	$\leq 30^{\circ}\text{C}/60\%$ RH	96 <sup>1</sup> +5/-0	$30^{\circ}\text{C}/60\%$ RH	20 +5/-0	$60^{\circ}\text{C}/60\%$ RH
5	48 hours	$\leq 30^{\circ}\text{C}/60\%$ RH	72 <sup>1</sup> +5/-0	$30^{\circ}\text{C}/60\%$ RH	15 +5/-0	$60^{\circ}\text{C}/60\%$ RH
5a	24 hours	$\leq 30^{\circ}\text{C}/60\%$ RH	48 <sup>1</sup> +5/-0	$30^{\circ}\text{C}/60\%$ RH	10 +5/-0	$60^{\circ}\text{C}/60\%$ RH
6	Time on label (TOL)	$\leq 30^{\circ}\text{C}/60\%$ RH	TOL	$30^{\circ}\text{C}/60\%$ RH		

### Note:

1. The standard soak time includes a default value of 24 hours for semiconductor manufacturer's exposure time (MET) between bake and bag, and includes maximum time allowed out of the bag at the distributor's facility.

## Reliability Items and Failure Measures

### Reliability test

The following table describes operating life, mechanical, and environmental tests performed on PLCC 5050 series.

<Table 7 Operating life, mechanical, and environmental characteristics for PLCC 5050 series>

Reliability Test 1			
Stress Test	Stress Conditions	Stress Duration	Failure Criteria
Temperature and Humidity	60°C / 60%RH	120 hours	No catastrophics
IR Reflow	Peak temp.=255~260°C *3 times	3 times	No catastrophics
Reliability Test 2			
Stress Test	Stress Conditions	Stress Duration	Failure Criteria
Room Temperature Operating Life	25°C, I <sub>F</sub> = max DC (Note 2)	1000 hours	No catastrophics
High Temperature and high Humidity Life	85°C / 85%RH, I <sub>F</sub> = 5 mA	1000 hours	No catastrophics
Low Temperature Storage	-40°C	1000 hours	No catastrophics
High Temperature and high Humidity Storage	85°C / 85%RH	1000 hours	No catastrophics
Ambient Temperature Life	25°C, I <sub>F</sub> = 20 mA	1000 hours	No catastrophics
Temperature Cycle	-40°C/100°C ,30 min dwell <15min transfer	200 cycles	No catastrophics
Thermal Shock	-40 / 100°C, 15 min dwell <10 sec transfer	200 cycles	No catastrophics

#### Notes:

1. Reliability test 2 is performed after reliability test 1
2. Depending on the maximum derating curve.
3. Failure Criteria:  
 Electrical failures  
 V<sub>F</sub> Shift >=10%  
 Luminous Intensity  
 I<sub>V</sub> Decay >= 35%



## Color Spectrum and Radiation Pattern

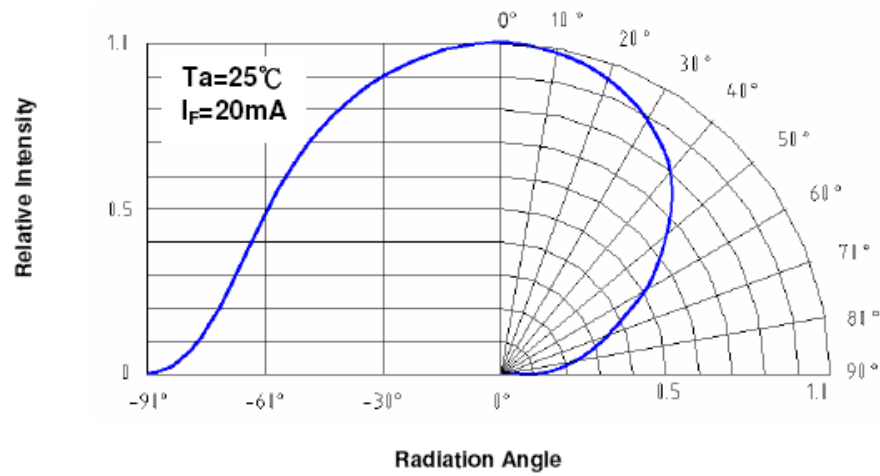

<Figure 3 Beam pattern diagram for PLCC 5050 series >

< Table 8 Viewing angle for PLCC 5050 series >

Part Name	Color	2 $\theta$ $\frac{1}{2}$ (Typ.) Lambertian	Unit
ET-5050W-3F1W	Cool White	120	Deg.

## Color Temperature or Dominant Wavelength Characteristics at Ta=25°C

< Table 9 Dominant Wavelength or Peak wavelength or Color Temperature Characteristics at Ta=25°C for PLCC 5050 series >

Part Name	Color	CCT		Unit
		Min.	Max.	
ET-5050W-3F1W	Cool White	5,000	10,000	K

### Note:

- Color Temperature is measured with an accuracy of  $\pm 200K$

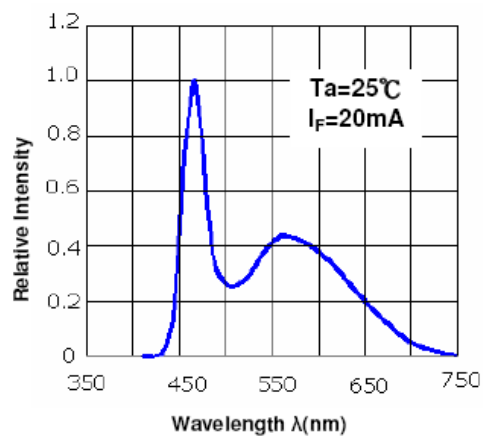

< Figure 4 Wavelength & relative intensity for PLCC 5050 series.>

## Optical & Electrical Characteristics

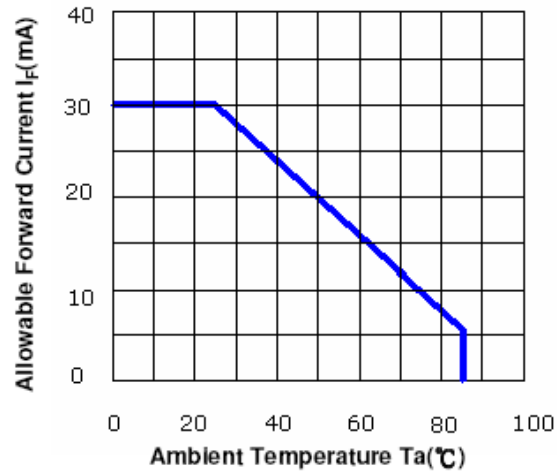

< Figure 5 Ambient temperature & forward current for PLCC 5050 series >

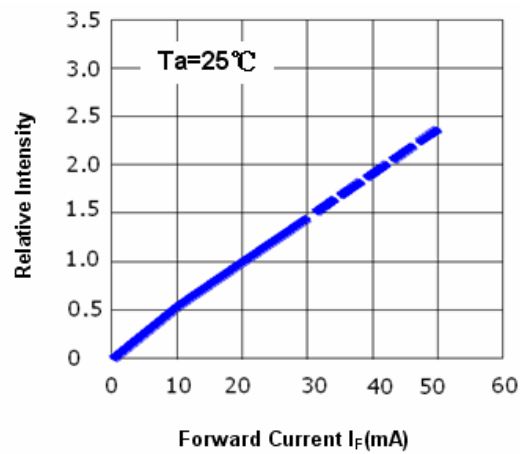

< Figure 6 Forward current & relative intensity for PLCC 5050 series >

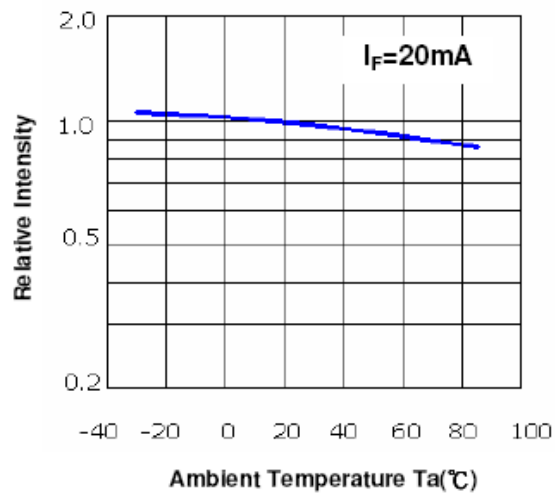

< Figure 7 Ambient temperature & relative intensity for PLCC 5050 series >

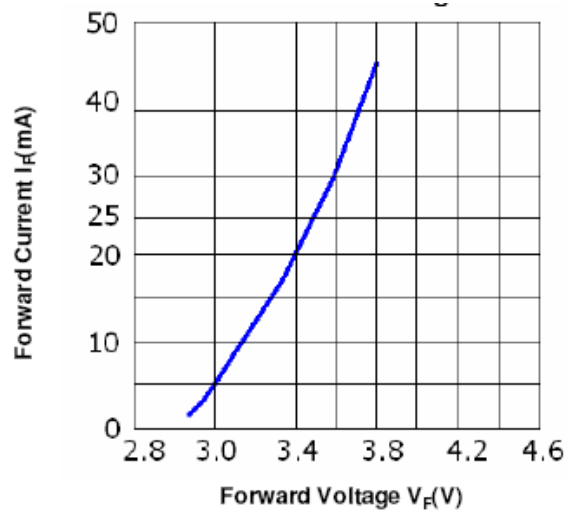

< Figure 8 Forward current & forward voltage for PLCC 5050 series >

## Product Soldering Instructions

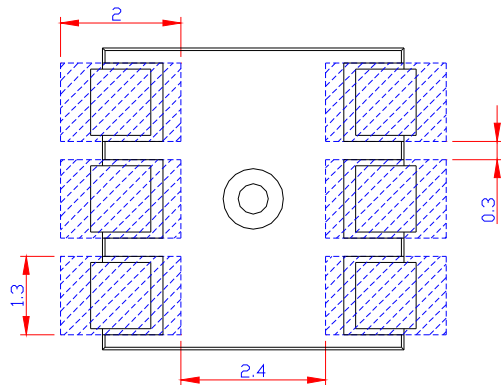

<Figure 9 Pad dimensions >

### Note:

1. All dimensions are measured in mm.

The following reflow soldering profiles are provided for reference. It is recommended that users follow the recommended soldering profile provided by the manufacturer of the solder paste used

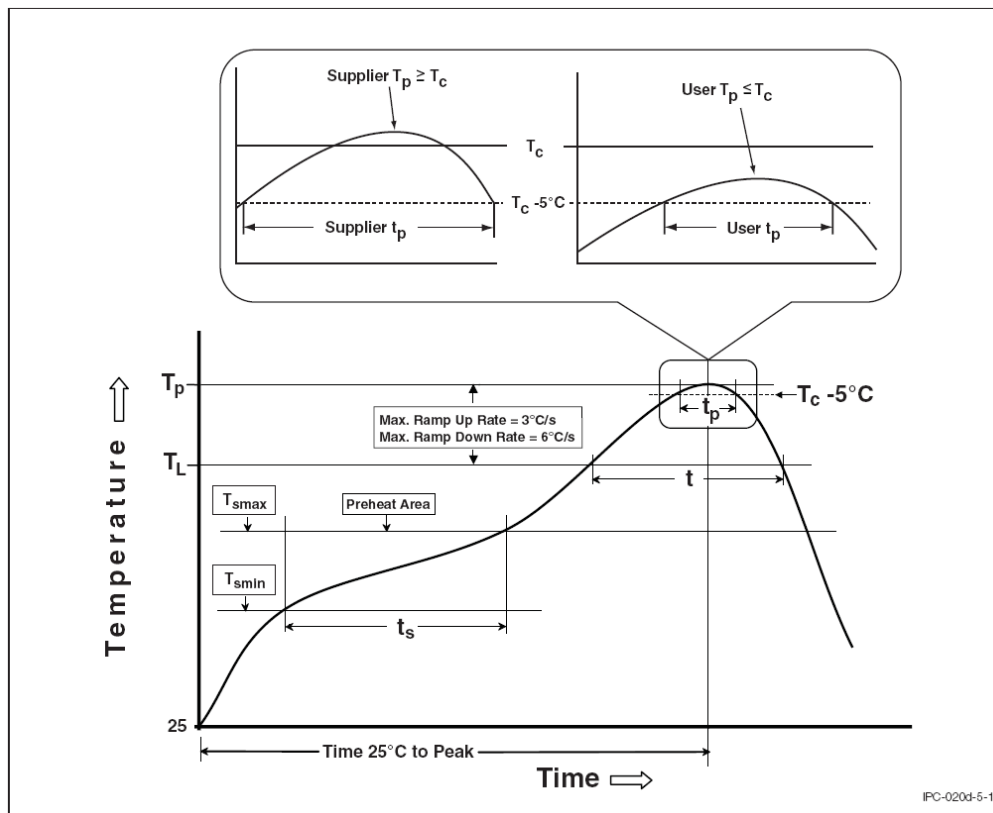

< Figure 10 Time-temperature of JEDEC J-STD-020D >

### Table of Classification Reflow Profiles

< Table 10 Reflow profiles >

Profile Feature	Sn-Pb Eutectic Assembly	Pb-Free Assembly
Preheat & Soak Temperature min (T <sub>smin</sub> ) Temperature max (T <sub>smax</sub> ) Time (T <sub>smin</sub> to T <sub>smax</sub> ) (t <sub>s</sub> )	100 °C 150 °C 60-120 seconds	150 °C 200 °C 60-120 seconds
Average ramp-up rate (T <sub>smax</sub> to T <sub>p</sub> )	3 °C/second max.	3 °C/second max.
Liquidous temperature (T <sub>L</sub> ) Time at liquidous (t <sub>L</sub> )	183 °C 60-150 seconds	217 °C 60-150 seconds
Peak package body temperature (T <sub>p</sub> )*	230 °C ~235 °C *	255 °C ~260 °C *
Classification temperature (T <sub>c</sub> )	235 °C	260 °C
Time (t <sub>p</sub> )** within 5 °C of the specified classification temperature (T <sub>c</sub> )	20** seconds	30** seconds
Average ramp-down rate (T <sub>p</sub> to T <sub>smax</sub> )	6 °C/second max.	6 °C/second max.
Time 25 °C to peak temperature	6 minutes max.	8 minutes max.

\* Tolerance for peak profile temperature (T<sub>p</sub>) is defined as a supplier minimum and a user maximum.

\*\* Tolerance for time at peak profile temperature (t<sub>p</sub>) is defined as a supplier minimum and a user maximum.

## Product Packaging Information

### Taping Reel

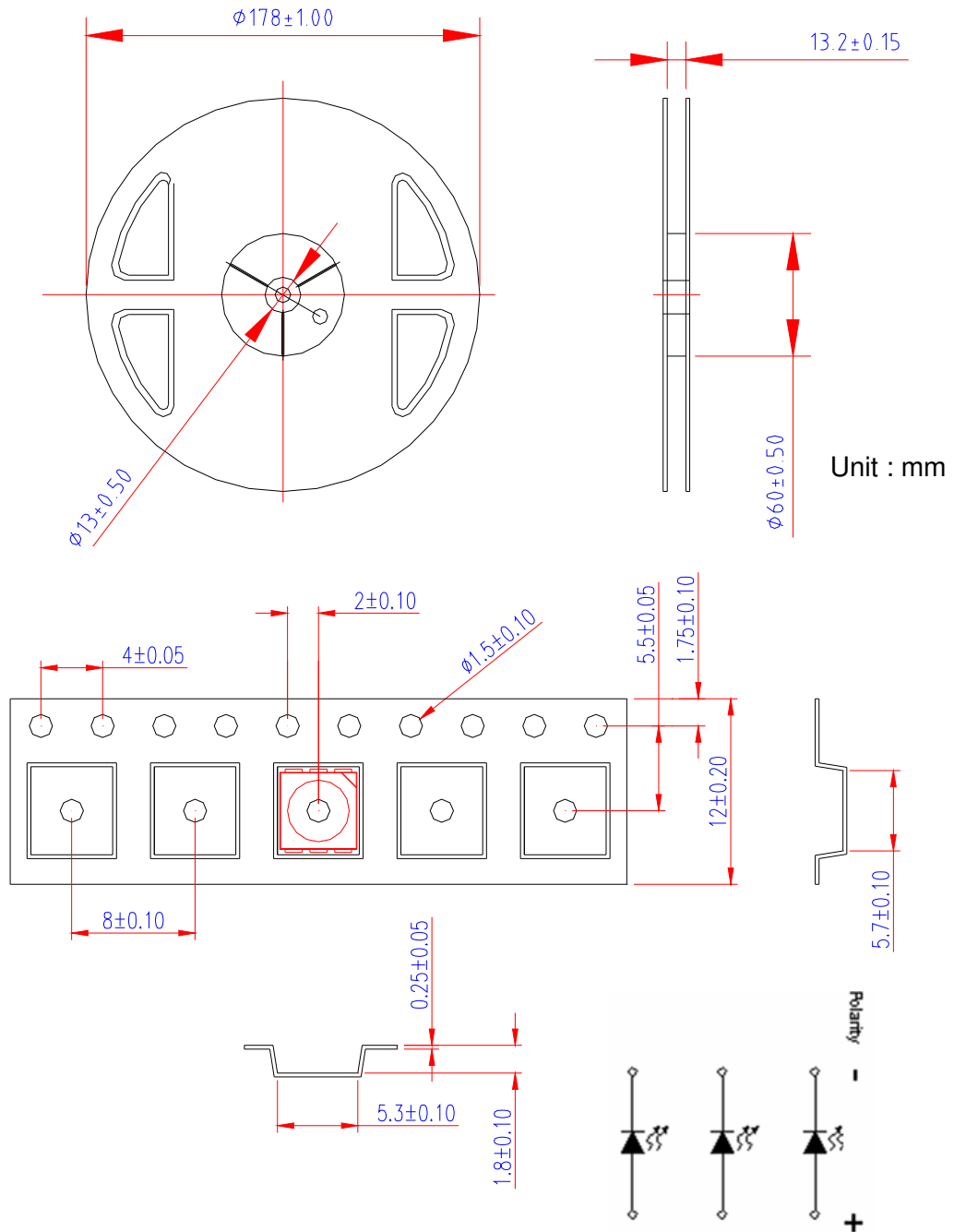

< Figure 11 Taping reel dimensions >

## Packaging

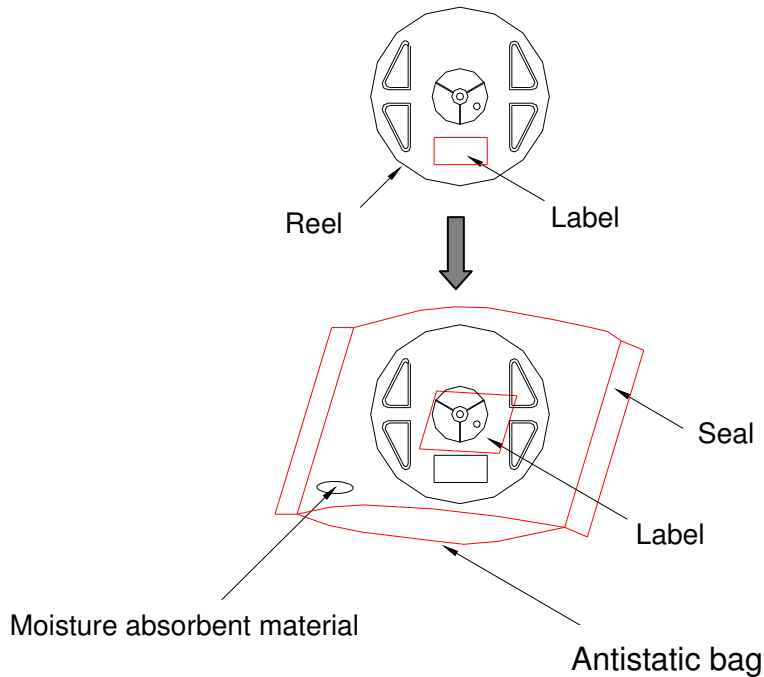

< Figure 12 Packaging diagram >

## Package Label

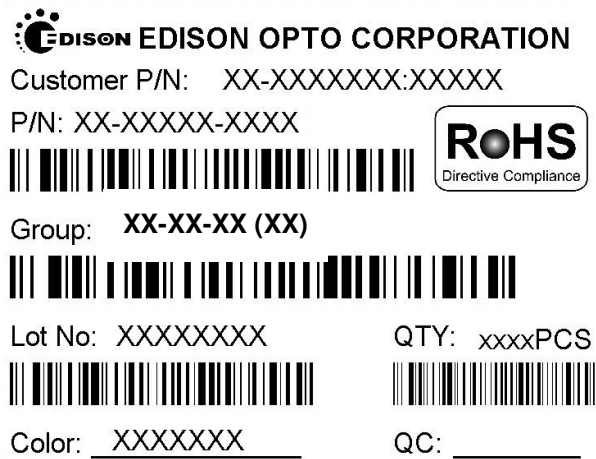

< Figure 13 Package label >

< Table 11 Package dimensions and quantity >

Item	Quantity	Total	Dimensions(mm)
Reel	1,000pcs	1,000pcs	Diameter=178
Inner box	5 reels	5,000pcs	240*235*67
Outer box	10 inner boxes	50,000pcs	500*260*355mm

---

## Precaution for Use

### Storage

#### **1.1 Before opening the package**

The LEDs should be kept at  $<40^{\circ}\text{C}$  &  $<90\%RH$ . The LEDs should be used within a year. When storing the LEDs, moisture proof package with absorbent material (silica gel) is recommended.

#### **1.2 After opening the package**

The LEDs should be kept at  $\leq 30^{\circ}\text{C}$  &  $\leq 60\%RH$ . The LEDs should be soldered within 168 hours (7days) after opening the moisture proof package.

If unused LEDs remain, they should be stored in moisture proof packages, such as sealed containers with moisture proof package within absorbent material (silica gel). It is also recommended to return the unused LEDs to the original moisture proof package and to seal the moisture proof package again.

If the moisture absorbent material (silica gel) vapors or expires the expiration date, baking treatment should be performed by using the following conditions:  $60^{\circ}\text{C}$  for 20 hours.

The LEDs electrode and leadframe comprise a silver plated copper alloy. The silver surface may be affected by environments. Please avoid conditions which may cause the LEDs being corroded or discolored. The corrosion or discoloration might lower solderability or affect optical characteristics.

Please avoid rapid transition in ambient temperature, especially in high humidity environments where condensation can occur.

### Static electricity

The products are sensitive to static electricity and highly taken care when handling them.

Static electricity or surge voltage will damage the LEDs. It is recommended to wear an anti-electrostatic wristband or an anti-electrostatic glove when handling the LEDs.

All devices, equipments and machinery must be properly grounded. It is recommended that measures be taken against surge voltage to the equipment that mounts the LEDs.



**Note:**

All the information published is considered to be reliable. However, EDISON OPTO does not assume any liability arising out of the application or use of any product described herein.

EDISON OPTO reserves the right to make changes at any time without notice to any products in order to improve reliability, function or design.

EDISON OPTO products are not authorized for use as critical components in life support devices or systems without the express written approval from the managing director of EDISON OPTO.

## Forward Voltage Ranks

< Table 12 Forward voltage rank at Ta=25°C >

Bin	Condition	Min	Max	Unit
UJ	IF=20mA/chip	2.8	3.0	V
UK		3.0	3.2	
UL		3.2	3.4	
UM		3.4	3.6	
UN		3.6	3.8	

**Note:**

1. Forward voltage measurement allowance is  $\pm 0.1V$ .

## Luminous Intensity Ranks

< Table 13 Luminous intensity rank at Ta=25°C >

Bin	Condition	Min	Max	Unit
ZL	20mA/chip	2,650	3,250	mcd
ZM		3,250	3,950	
ZN		3,950	4,850	
ZO		4,850	5,950	
ZP		5,950	7,250	

**Note:**

1. Luminous Intensity Measurement Allowance is  $\pm 10\%$ .

## CIE Chromaticity Diagram

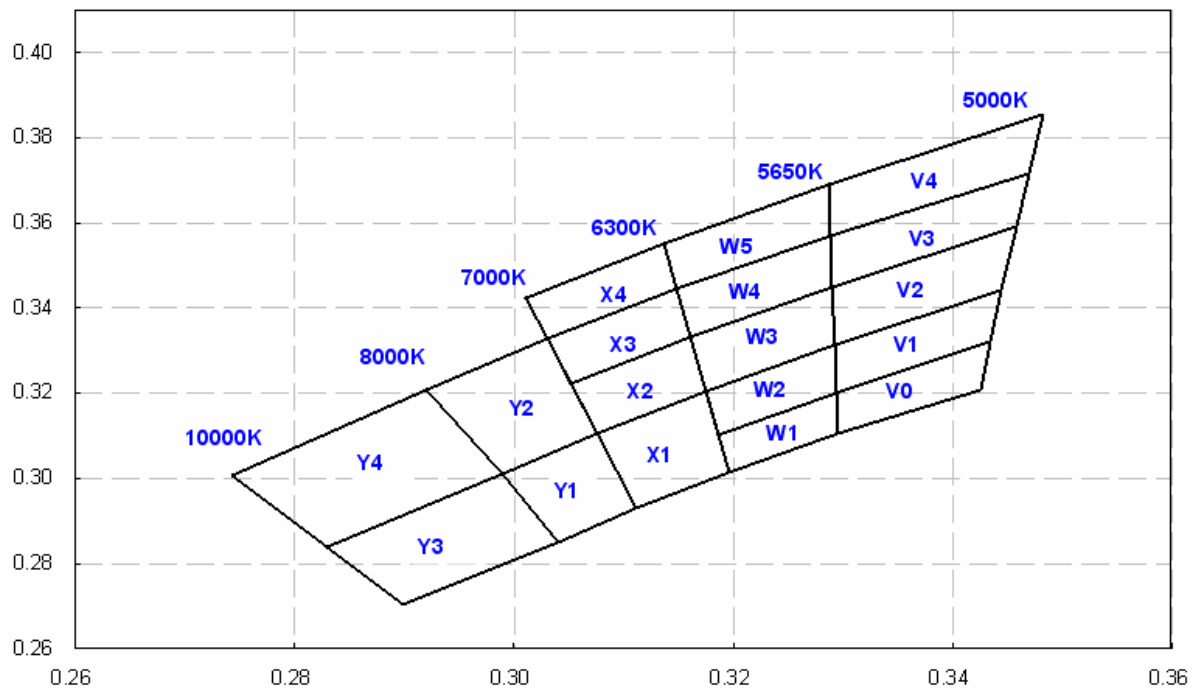

< Figure 14 PLCC 5050 series chromaticity diagram >

## Color Bin

< Table 14 Color Bin Y1-W5 at  $I_F=20\text{mA}$  ,  $T_a=25^\circ\text{C}$  for PLCC 5050 series >.

Bin	Chromaticity Coordinate				
Y1	X	0.3040	0.2990	0.3075	0.3111
	Y	0.2850	0.3010	0.3107	0.2931
Y2	X	0.2990	0.2920	0.3030	0.3075
	Y	0.3010	0.3210	0.3327	0.3107
Y3	X	0.3040	0.2899	0.2829	0.2990
	Y	0.2850	0.2703	0.2837	0.3010
Y4	X	0.2920	0.2742	0.2829	0.2990
	Y	0.3210	0.3006	0.2837	0.3010
X1	X	0.3075	0.3174	0.3196	0.3111
	Y	0.3107	0.3204	0.3013	0.2931
X2	X	0.3075	0.3051	0.3160	0.3174
	Y	0.3107	0.3223	0.3332	0.3204
X3	X	0.3051	0.3030	0.3147	0.3160
	Y	0.3223	0.3327	0.3444	0.3332
X4	X	0.3030	0.3010	0.3136	0.3147
	Y	0.3327	0.3422	0.3549	0.3444
W1	X	0.3292	0.3295	0.3196	0.3186
	Y	0.3202	0.3105	0.3013	0.3102
W2	X	0.3292	0.3293	0.3186	0.3174
	Y	0.3313	0.3202	0.3102	0.3204
W3	X	0.3290	0.3292	0.3174	0.3160
	Y	0.3450	0.3313	0.3204	0.3332
W4	X	0.3290	0.3160	0.3147	0.3288
	Y	0.3450	0.3332	0.3444	0.3569
W5	X	0.3147	0.3136	0.3186	0.3288
	Y	0.3444	0.3549	0.3689	0.3569

### Note:

1. Color coordinates measurement allowance is  $\pm 0.01$

< Table 15 Color Bin V0-V4 at  $I_F=20\text{mA}$  ,  $T_a=25^\circ\text{C}$  for PLCC 5050 series >

Bin	Chromaticity Coordinate				
V0	X	0.3433	0.3425	0.3293	0.3293
	Y	0.3320	0.3208	0.3105	0.3200
V1	X	0.3292	0.3444	0.3433	0.3293
	Y	0.3313	0.3442	0.3320	0.3200
V2	X	0.3292	0.3290	0.3457	0.3444
	Y	0.3313	0.3450	0.3591	0.3442
V3	X	0.3290	0.3288	0.3469	0.3457
	Y	0.3450	0.3569	0.3717	0.3591
V4	X	0.3288	0.3286	0.3481	0.3469
	Y	0.3569	0.3689	0.3856	0.3717

**Note:**

1. Color coordinates measurement allowance is  $\pm 0.01$