

Part: HL-1003U3YD



**ATTENTION**  
OBSERVE PRECAUTIONS  
FOR HANDLING  
ELECTROSTATIC  
DISCHARGE  
SENSITIVE  
DEVICES



**Features:**

- $\phi 10$  LAMP LED
- LOW POWER CONSUMPTION.
- CABINED VIEWING ANGLE.
- IDEAL FOR BACKLIGHT AND INDICATOR.
- PACKAGE: 200PCS / BAG.

**Description:**

This devices are made with TS GaAsP.

**Package Dimensions:**

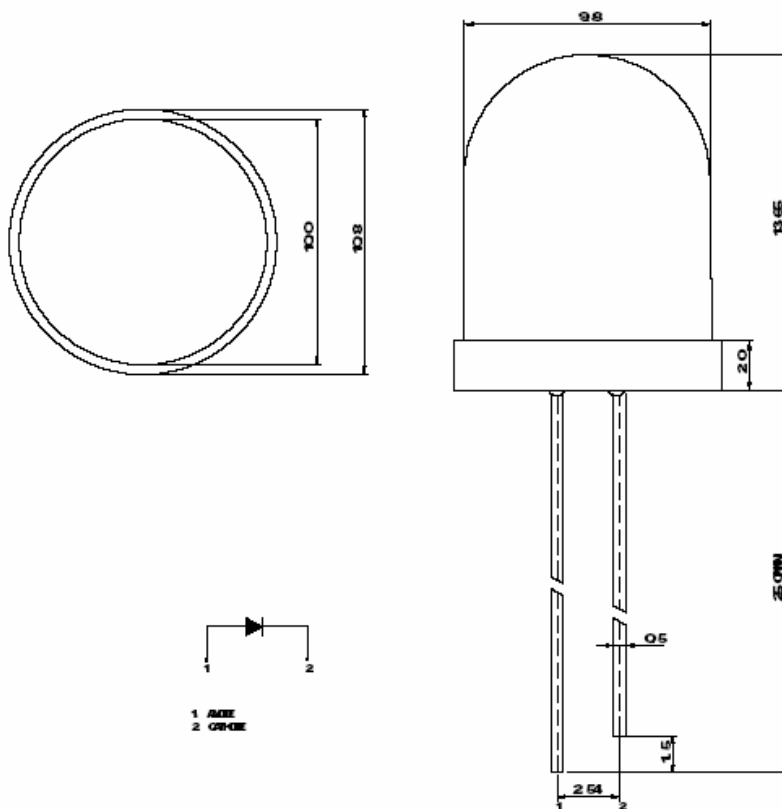

Tolerance Grade	Dimension Tolerance (UNIT:mm)			
	0.5~3	3~6	6~30	30~120
Medium(m)	±0.1	±0.2	±0.3	±0.5
<b>Chip</b>		<b>Lens Color</b>		
Material	Emitting Color	Color Diffused		
GaAsP/GaAs	Yellow			

**■Absolute Maximum Rating**

Item	Symbol	Absolute Maximum Rating	Unit
Forward Current	IF	20	mA
Peak Forward Current*	IFP	100	mA
Reverse Voltage	VR	5	V
Power Dissipation	PD	80	mW
Electrostatic discharge	ESD	2000	V
Operation Temperature	Topr	-30~+80	°C
Storage Temperature	Tstg	-30~+80	°C
Lead Soldering Temperature*	Tsol	Max. 260°C for 5sec Max.	

\* IFP Conditions: Pulse Width≤10msec

\* Tsol Conditions: 3mm from the base of the epoxy bulb

**■Typical Optical/ Electrical Characteristics**

Item	Symbol	Condition	Min.	Typ.	Max.	Unit
Forward Voltage	VF	IF=20mA	1.8	2.2	2.6	V
50% Power Angle	2θ 1/2		--	50	--	deg
Luminous Intensity	Iv		735	900	--	mcd
Dominant Wavelength	λD		585	--	595	nm
Recommend Forward Current	IF(rec)	--	--	--	20	mA
Reverse Current	IR	Vr=5V	--	--	10	uA

Notes:

1. Absolute maximum ratings Ta=25°C.
2. Tolerance of measurement of forward voltage±0.1V.
3. Tolerance of measurement of peak Wavelength±2.0nm.
4. Tolerance of measurement of luminous intensity±15%.
5. Tolerance of measurement of angle intensity±15%.

**■Reliability Performance Test Items And Result**

Test Classification	Test Item	Test Conditions	Test Duration	Sample Size	AC/RE
Life Test	Room Temperature DC Operating Life Test	Ta=25°C ±5°C, IF=20mA	1000 hrs	22 pcs	0/1
Environment Test	Thermal Shock Test	100°C ±5°C 5min ↑↓ -40°C ±5°C 5min.	100 cycles	22 pcs	0/1
	Temperature Cycle Test	100°C ±5°C 30min ↑↓5min -40°C ±5°C 30min.	100 cycles	22 pcs	0/1
	Temperature & Cycle Test	85°C ±5°C /85% RH IF=5mA	1000 hrs	22 pcs	0/1
	Temperature Cycle Test	Ta=100°C ±5°C	1000 hrs	22 pcs	0/1
	Low Temperature Storage	Ta=100°C ±5°C	1000 hrs	22 pcs	0/1
Mechanical Test	Resistance to Soldering Heat	Ta=100°C ±5°C	1times	22 pcs	0/1
	Lead Integrity	Load 2.5N(0.25kgf) 0° ~ 90° ~ 0°	3times	22 pcs	0/1

The technical information shown in the data sheets are limited to the typical characteristics and circuit examples of the referenced. It does not constitute the warranting of industrial property nor the granting of any license.

**Forward Current vs. Ambient Temperature**

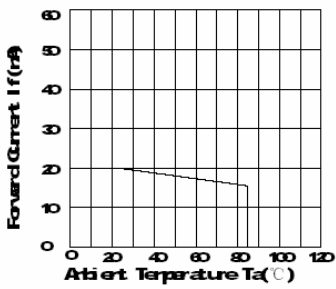

**Relative Intensity vs. Ambient Temperature**

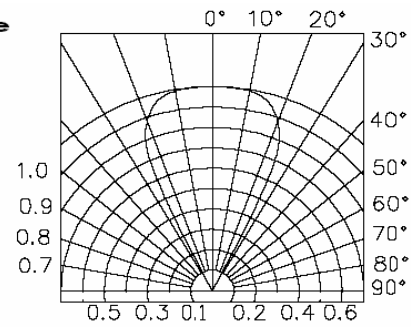
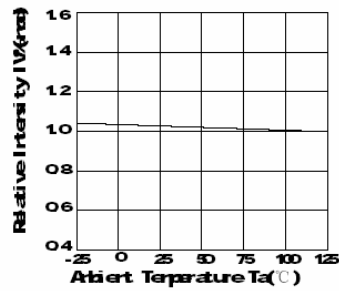

**Forward Current vs. Forward Voltage**

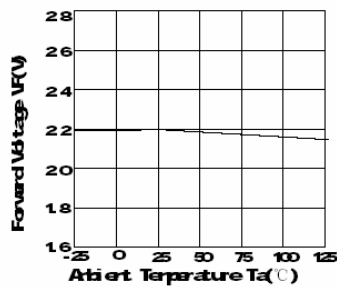
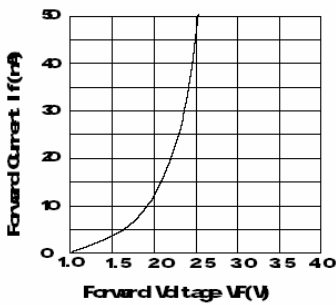

**Luminous Spectrum ( $T_a=25^\circ\text{C}$ ) SPECTRAL RADIANCE**

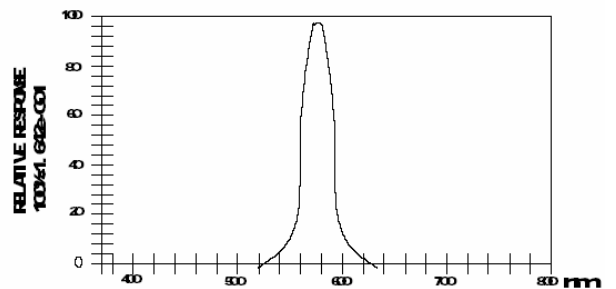

**Soldering:**

**1. Manual Of Soldering**

The temperature of the iron tip should not be higher than 260°C (500°F) and Soldering within 3 seconds per solder-land is to be observed.

**2. DIP soldering (Wave Soldering):**

Preheating: 120°C ~150°C, within 120~180 sec.

Operation heating: 245°C ±5°C within 5 sec. 260°C (Max)

Gradual Cooling (Avoid quenching).

