

Part: HL-308H238WC-MD

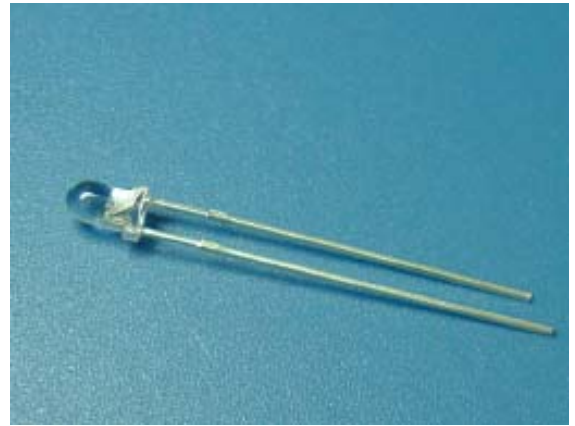

ATTENTION
OBSERVE PRECAUTIONS
FOR HANDLING
ELECTROSTATIC
DISCHARGE
SENSITIVE
DEVICES



Features:

- $\phi 3$ LAMP LED
- LOW POWER CONSUMPTION.
- CABINED VIEWING ANGLE.
- IDEAL FOR BACKLIGHT, LIGHTING AND INDICATOR.
- PACKAGE: 1000PCS / BAG.

Description:

This devices are made with TS InGaN.

Package Dimensions:

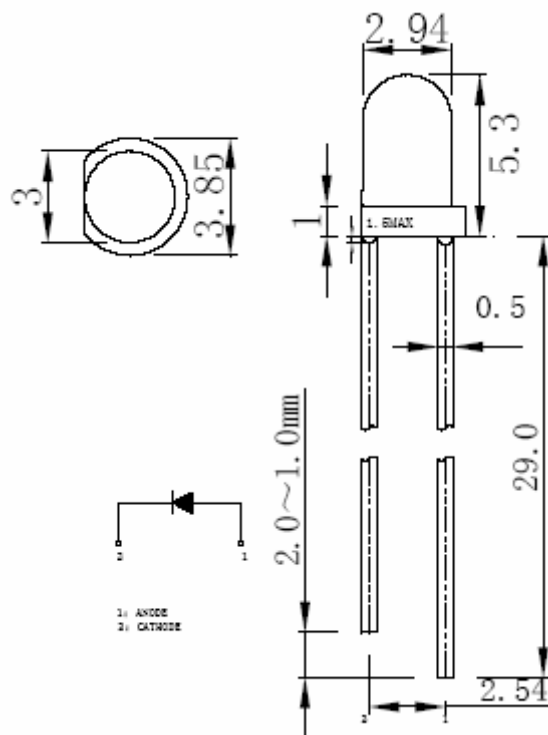

Tolerance Grade	Dimension Tolerance (UNIT:mm)			
	0.5~3	3~6	6~30	30~120
Medium(m)	±0.1	±0.2	±0.3	±0.5
Chip		Lens Color		
Material	Emitting Color	Water Clear		
InGaN	White			

■ Absolute Maximum Rating

Item	Symbol	Absolute Maximum Rating	Unit
Forward Current	IF	20	mA
Peak Forward Current*	IFP	100	mA
Reverse Voltage	VR	5	V
Power Dissipation	PD	80	mW
Electrostatic discharge	ESD	1500	V
Operation Temperature	Topr	-30~+80	°C
Storage Temperature	Tstg	-30~+80	°C
Lead Soldering Temperature*	Tsol	Max. 260°C for 5sec Max.	

* IFP Conditions: Pulse Width≤10msec

* Tsol Conditions: 3mm from the base of the epoxy bulb

■ Typical Optical/ Electrical Characteristics

Item	Symbol	Condition	Min.	Typ.	Max.	Unit
Forward Voltage	VF	IF=20mA	2.8	3.2	3.6	V
50% Power Angle	2θ 1/2		--	25	--	deg
Luminous Intensity	Iv		8280	9000	10750	mcd
Chromaticity coordinates	X		--	0.31	--	X: ±0.015
	Y		--	0.32	--	Y: ±0.025
Prpc Wavelength	λD	--	--	--	nm	
Recommend Forward Current	IF(rec)	--	--	--	20	mA
Reverse Current	IR	Vr=5V	--	--	10	uA

Notes:

1. Absolute maximum ratings Ta=25°C.
2. Tolerance of measurement of forward voltage±0.1V.
3. Tolerance of measurement of peak Wavelength±2.0nm.
4. Tolerance of measurement of luminous intensity±15%.
5. Tolerance of measurement of angle intensity±15%.

■ Reliability Performance Test Items And Result

Test Classification	Test Item	Test Conditions	Test Duration	Sample Size	AC/RE
Life Test	Room Temperature DC Operating Life Test	Ta=25°C ±5°C, IF=20mA	1000 hrs	22 pcs	0/1
Environment Test	Thermal Shock Test	100°C ±5°C 5min ↑↓ -40°C ±5°C 5min.	100 cycles	22 pcs	0/1
	Temperature Cycle Test	100°C ±5°C 30min ↑↓5min -40°C ±5°C 30min.	100 cycles	22 pcs	0/1
	Temperature & Cycle Test	85°C ±5°C /85% RH IF=5mA	1000 hrs	22 pcs	0/1
	Temperature Cycle Test	Ta=100°C ±5°C	1000 hrs	22 pcs	0/1
	Low Temperature Storage	Ta=100°C ±5°C	1000 hrs	22 pcs	0/1
Mechanical Test	Resistance to Soldering Heat	Ta=100°C ±5°C	1times	22 pcs	0/1
	Lead Integrity	Load 2.5N(0.25kgf) 0° ~ 90° ~ 0°	3times	22 pcs	0/1

The technical information shown in the data sheets are limited to the typical characteristics and circuit examples of the referenced. It does not constitute the warranting of industrial property nor the granting of any license.

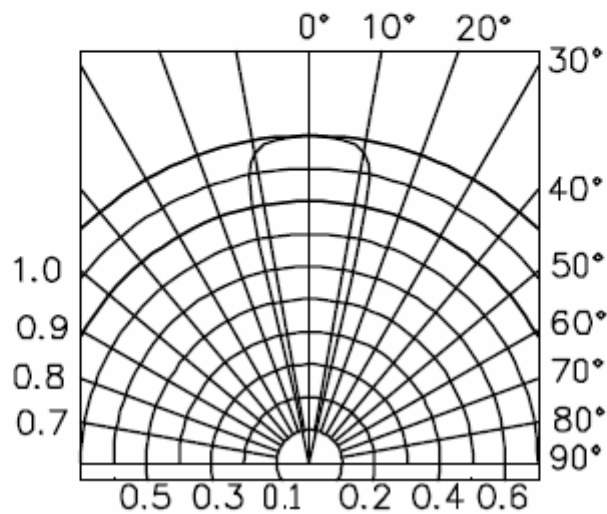
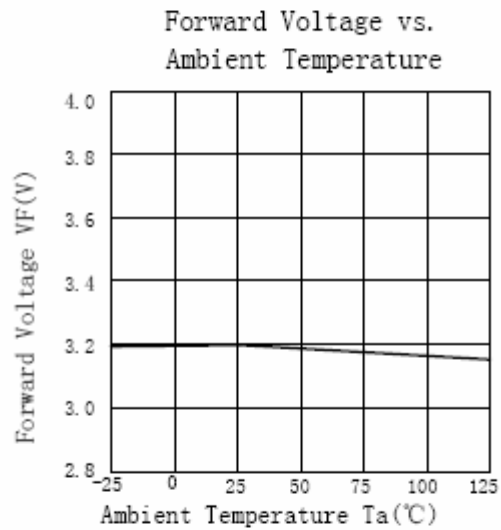
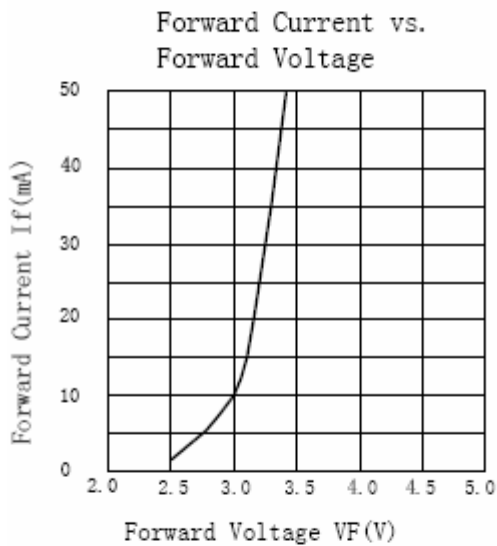
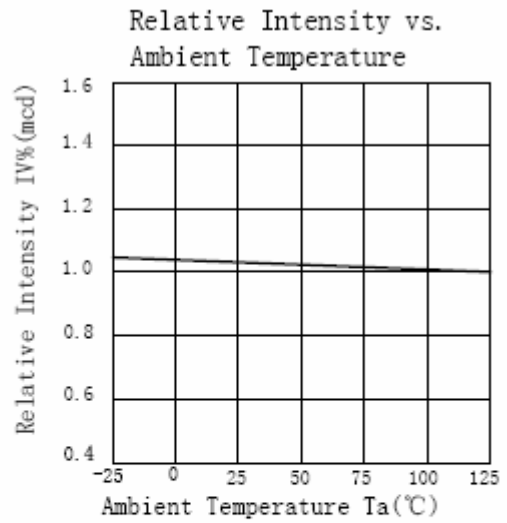
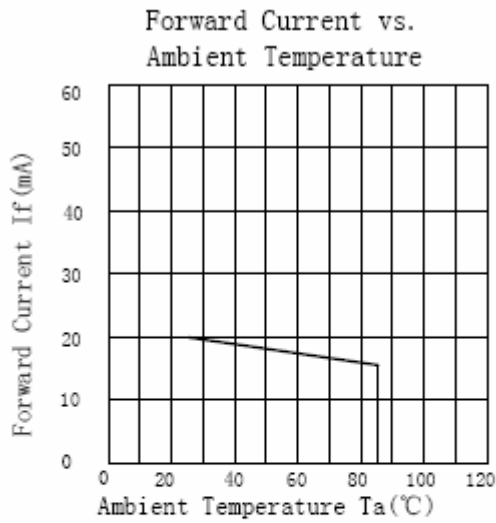

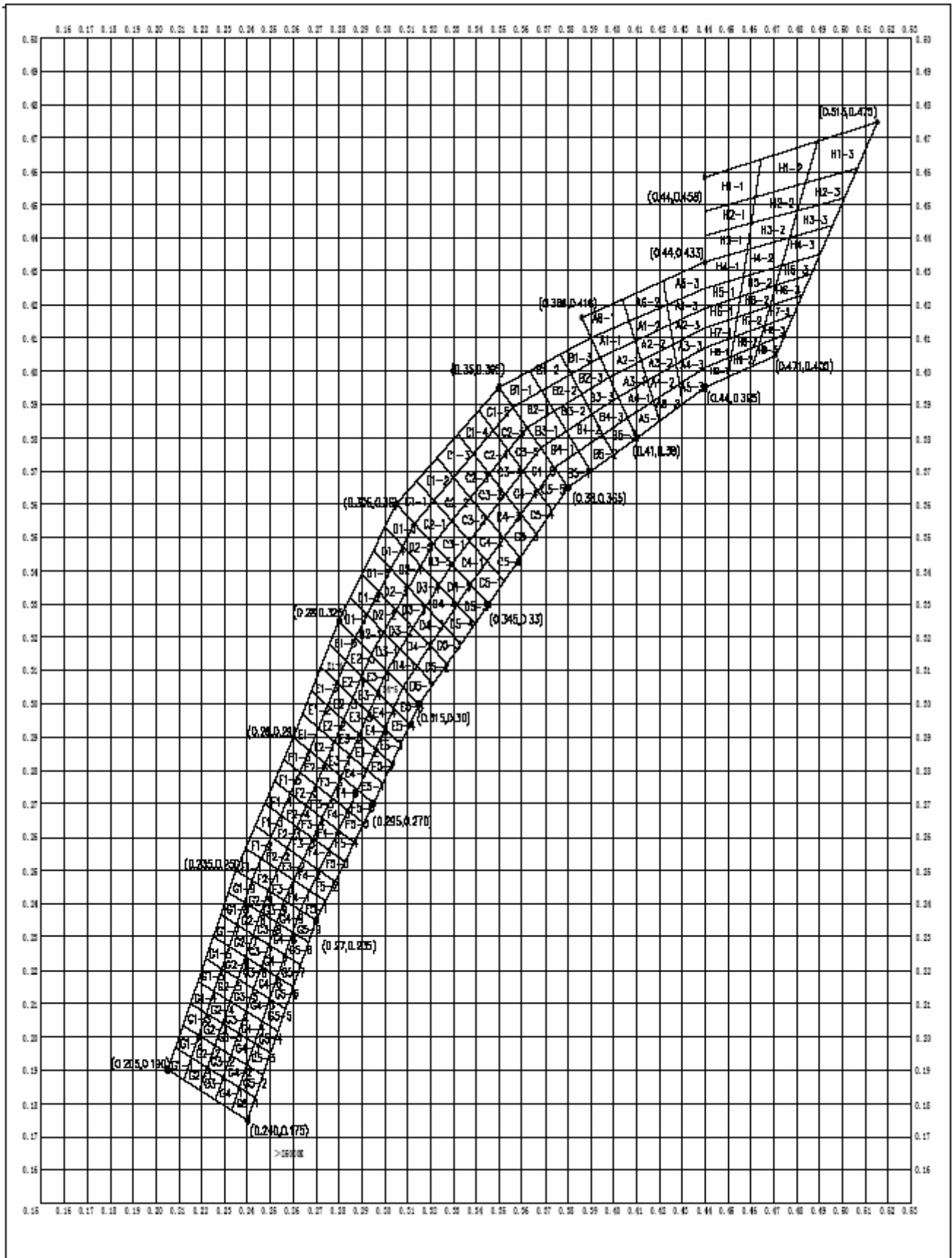

Soldering:

1. Manual Of Soldering

The temperature of the iron tip should not be higher than 260°C (500°F) and Soldering within 3 seconds per solder-land is to be observed.

2. DIP soldering (Wave Soldering):

Preheating: 120°C ~150°C, within 120~180 sec.

Operation heating: 245°C ±5°C within 5 sec. 260°C (Max)

Gradual Cooling (Avoid quenching).

