

LOW VOLTAGE DUAL POWER AMPLIFIER

■ GENERAL DESCRIPTION

The NJM2096 is a dual power amplifier, which operates with 1.0V minimum supply voltage. The NJM2096 is suitable to small radio and head-phone stereo. The NJM2096 is resemble to the NJM2076, but two amplifiers are the same.

■ FEATURES

- Low Operating Voltage (1.0V min)
- Minimum external components
- Low Operating Current
- Package Outline DIP8, DMP8, SIP9
- Bipolar Technology

■ APPLICATION

- Head-phone Stereo, Portable Radio, Portable TV, Hand-carry Tele-communication Set.

■ PIN CONFIGURATION

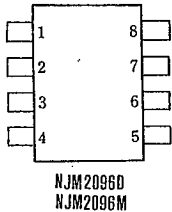

PIN FUNCTION

1. Non-Inverting Amp. Input (A)
2. Non-Inverting Amp. Input (B)
3. V⁺
4. Base (B)
5. (B) Output
6. GND
7. (A) Output
8. Base (A)

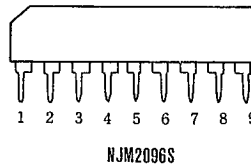

PIN FUNCTION

1. V⁺
2. Base (B)
3. (B) Output
4. Power GND
5. GND
6. (A) Output
7. Base (A)
8. Non-Inverting Amp. Input (A)
9. Non-Inverting Amp. Input (B)

■ PACKAGE OUTLINE

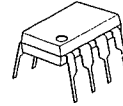

NJM 2096 D

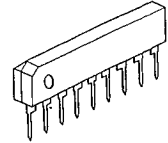

NJM 2096 S



NJM 2096 M

■ ABSOLUTE MAXIMUM RATINGS

(Ta=25°C)

PARAMETER	SYMBOL	RATINGS	UNIT
Supply Voltage	V ⁺	4.5	V
Power Dissipation	P _D	(DIP8) 500 (SIP9) 500 (DMP8) 300	mW
Maximum Input Signal	V _{IN}	200	mVrms
Operating Temperature Range	T _{opr}	-20~+75	°C
Storage Temperature Range	T _{stg}	-40~+125	°C

■ ELECTRICAL CHARACTERISTICS

(Ta=25°C, V⁺=1.5V, R_L=16Ω)

PARAMETER	SYMBOL	TEST CONDITION	MIN.	TYP.	MAX.	UNIT
Operating Current	I _{cc}	V _{IN} =Open	—	4.7	7	mA
Maximum Output Power	P _{OL}	THD=10% D&S	15	20	—	mW
		M	15	17.5	—	mW
Max. Output Power at Low Supply Voltage	P _O	THD=10%, V ⁺ = 1.0V	—	3	—	mW
Voltage Gain	A _v	V _{IN} =10mVrms	26.5	28	29.5	dB
Total Harmonic Distortion	THD	P _O =1mW	—	0.4	0.8	%
Ripple Rejection Ratio	RR	R _g =0Ω, V _r =30mVrms. F _r =1kHz	25	35	—	dB
Input Resistance	R _{IN}		25	33	43	kΩ
Output Noise Voltage	V _{NO}	R _g =0Ω, A Curve	—	40	150	μV
Output Pin Voltage	V _O (DC)		0.62	0.70	0.77	V
Voltage Difference between Two Output Pins	ΔV _O (DC)		—	—	50	mV

5

■ TEST CIRCUIT

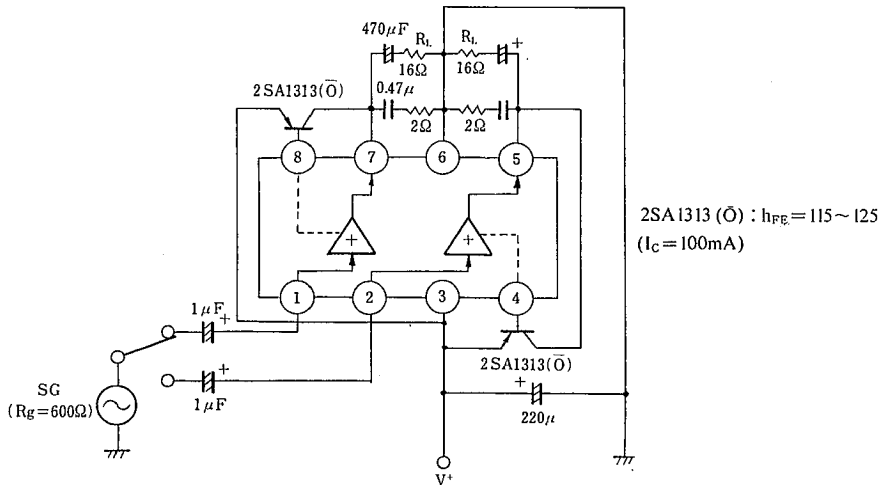

TYPICAL CHARACTERISTICS

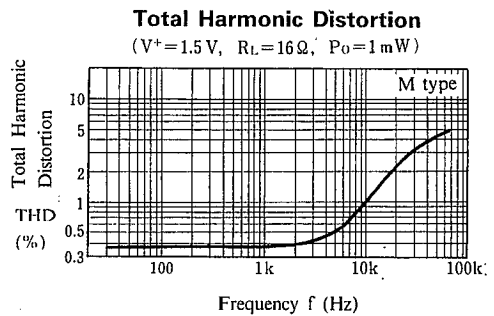
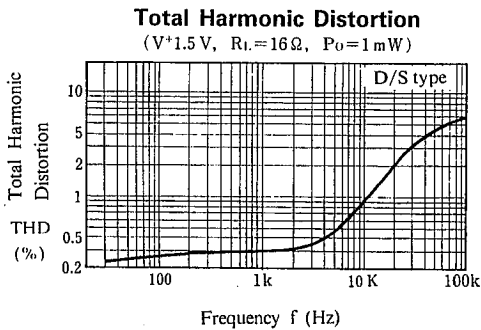
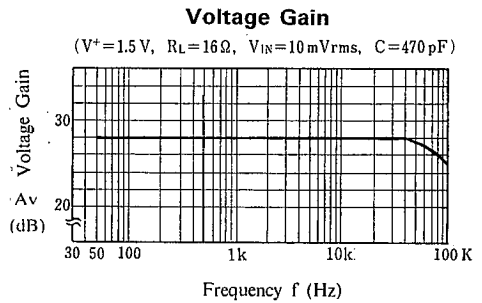
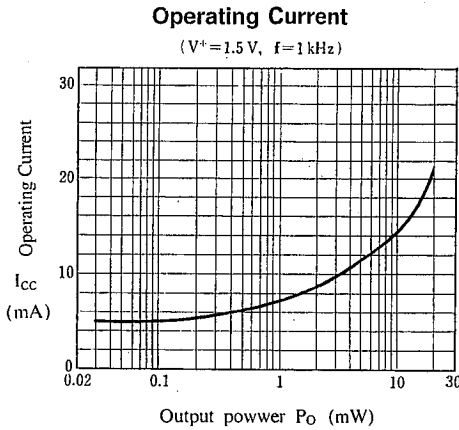
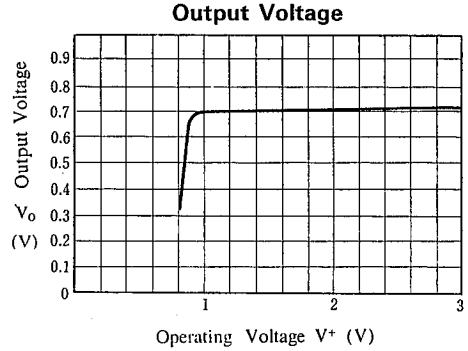
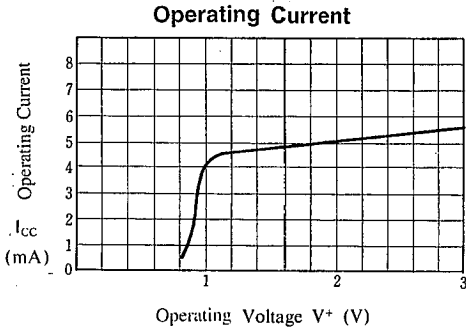

■ TYPICAL CHARACTERISTICS

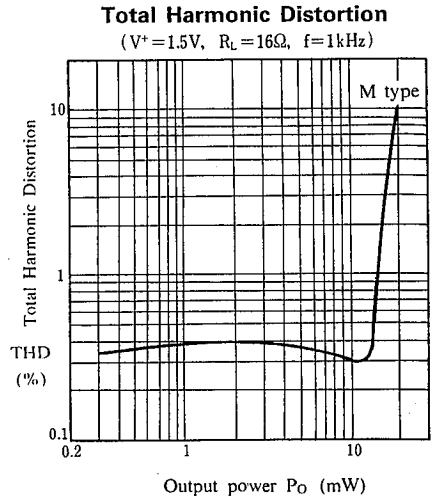
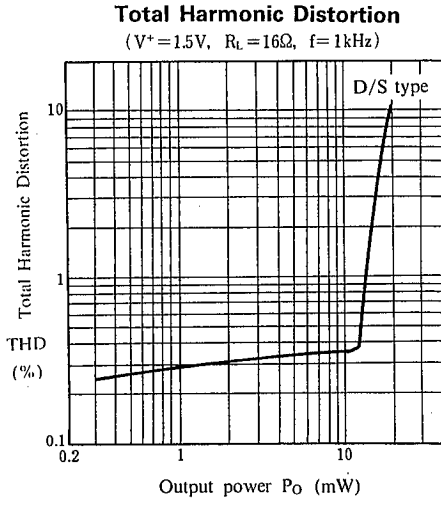

5

■ TYPICAL APPLICATION

Stereo Head-Phone

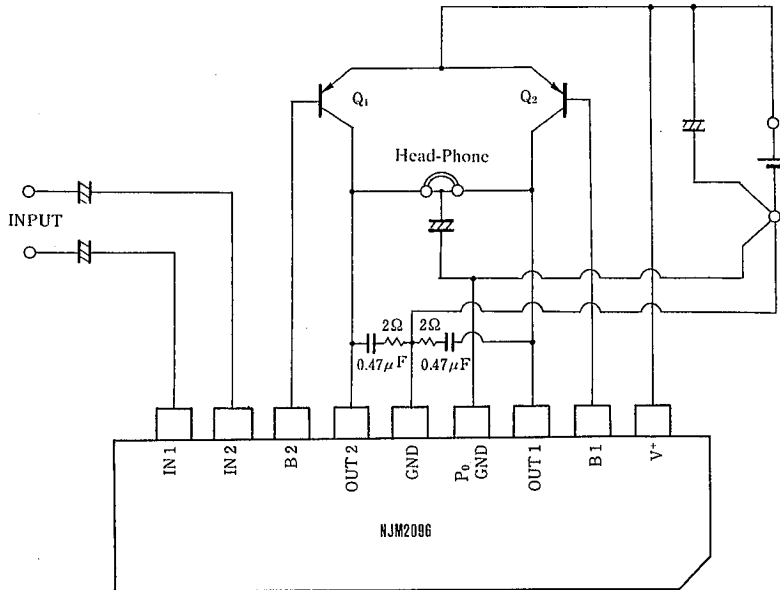

■ NOTICE

(1) External PNP Transistor

Maximum output power becomes large with low saturation voltage transistor, and so select transistor of low saturation voltage.
 $h_{FE} : 120$

(2) External Frequency Compensation

Recommend tantalum capacitor with low $\tan \delta$ (less than 0.25 at $f=10\text{kHz}$) and 2Ω resistor. Stable with large capacitor of less high frequency distortion and worse $\tan \delta$. For example: $1\mu\text{F}$, $\tan \delta \leq 0.6$

(3) Layout on PCB

Be careful to get maximum output power and low distortion set.

DIP/DMP: Signal ground has to be close to IC ground pin. Impedance of ground line must be low.

SIP: Two terminals (Power GND, GND) are connected at one point on PCB.

5

MEMO

[CAUTION]

The specifications on this databook are only given for information, without any guarantee as regards either mistakes or omissions. The application circuits in this databook are described only to show representative usages of the product and not intended for the guarantee or permission of any right including the industrial rights.